

SyringePump.com

New Era 9000 Series User Manual

Programmable Peristaltic Pump “Learn & Repeat”™

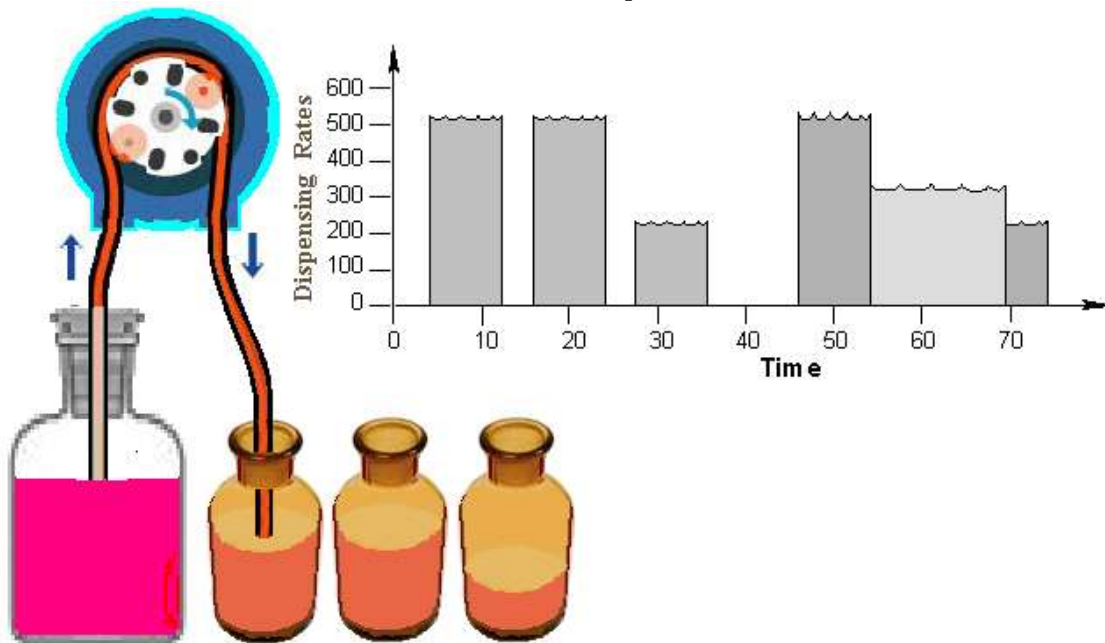

“WHAT’S YOUR APPLICATION?”™

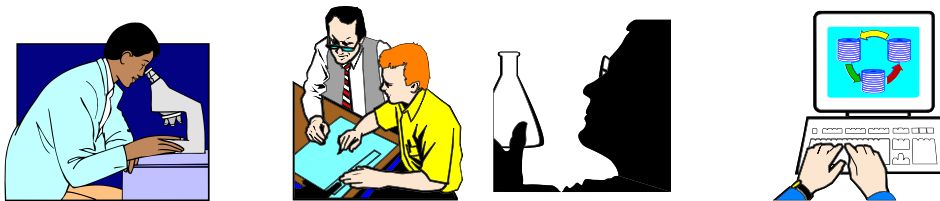

WARNING
NOT FOR CLINICAL
USE ON HUMANS

NE-9000 Peristaltic Pump

Quick Start Instructions

Assumes that the pump was not previously programmed with a multiple Phase Pumping Program. Otherwise execute pump reset.

- Plug in the pump. Use appropriate power supply.
- Press the power switch on the back of the pump to turn on power.
- Press any key to stop the display from blinking.

Setup Pumping Parameters

To Change Numbers:

- Press the up arrow keys to increment individual digits.
- **To set/clear the decimal point:** Simultaneously press the 2 up-arrow keys under the 2 digits next to the decimal point position.
- Press any non-arrow key, or wait for the display to blink. The new value is entered and stored in memory.

Peristaltic Tube ID (Inside Diameter):

- Tubing diameter is pre-set to 3/16" ID. See full instructions to change the default tubing diameter.

Set the Pumping Rate:

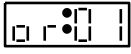
- Display the pumping rate by momentarily pressing the 'Rate' key.
- To change the **pumping rate units:**
 - Momentarily press the 'Rate' key again. The display will show: 
 - Press any up arrow key to select the next available rate units while they blink.
 - Press any non-arrow key, or wait for the time out to set the rate units.
- Set the pumping rate. If the pumping rate is out of range, the display will show: 

Set the Volume to be Dispensed or Set Continuous Pumping

- Display the volume by momentarily pressing the 'Volume' key. 'Dispensed' LED should be off.
- When the display shows , the pump is set for continuous pumping. Pressing any up arrow key will change the display to 0.
- For continuous pumping: Set the volume to 0.

- For a Volume to be Dispensed: Set the volume.
- To change volume units, momentarily press the 'Volume' key again. The 'Dispensed' LED should be lit. Use the up arrow keys to select the volume units.

Set the Pumping Direction

- When the 'Withdraw' LED is lit, the pump is set for withdrawing. When not lit, the pump is set for dispensing. Use the '↔' key to change the pumping direction.

Load the Peristaltic Tubing

- Prepare new tube with two tie wraps 5 3/8" apart, both knots facing the same direction.
- Remove pump head by turning cassette counterclockwise, Remove rotor.
- Add grease to pump Shaft and Tubing.
- Insert rotor onto Shaft, placing Tubing between Cassette and rotor. Tie Wrap knots facing Cassette.
- Install pump head to base by first, lining up rotor and driving axle, and second, applying forward pressure and rotating cassette clockwise until it enters its groove. Continue turning until it stops.

Prime/Purge Tubing: Press and hold the 'Start/Stop' key for one second. Release to stop.

Start the Pump: Momentarily press the 'Start/Stop' key to start or stop the pump.

While Pumping

- The pumping rate can be changed.
- With continuous pumping, the pumping direction can be changed.

PUMP RESET:

Press and hold the right-most up arrow key while turning on power to the pump.

Selecting Dispense Programs

Multiple dispense settings can be stored and selected as needed. The last selected dispensing program will be the default dispense program when the pump is powered on. Up to 40 dispense programs can be stored.

To view or select the current dispense program number, or to select a different program, press and hold either the **'Rate'** or **'Volume'** key. The display will show:

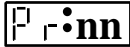

Where 'nn' indicates the currently selected dispense program. Use the up arrow keys to change the dispense program number. Press **'LEARN'** to select, or wait for the 5 second time out. The display will blink when selected.

Press the **'Start'** key to immediately start the selected dispense.

Press the **'Rate'** or **'Volume'** keys to display the settings for the selected dispense. Any changes made to the pumping rate or dispense volume will be stored in the selected dispense program.

Learn and Repeat

Learn and repeat easily teaches the pump a dispense volume. Then you can immediately repeat this dispense.

While turning on power, press and hold the **'LEARN'** key. The display will show:

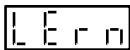

Press and hold the **'Start'** key to begin dispensing. As the desired volume is approached, you can release the key to stop the pump, then periodically press the **'Start'** key to slowly and accurately approach your dispense volume.

While pumping, the volume dispensed will be displayed. When the **'Start'** key is released, the display will alternate between displaying the volume dispensed and the currently selected dispense setting number.

Press the **'LEARN'** key, or wait for the time out, to immediately store the dispensed volume in the currently selected dispense setting. A double beep will sound and the display will show:

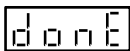

Press any key to return to the currently selected dispense program display. Press **'Start'** to immediately begin the newly learned dispensed.

The learned dispense can be stored in a different dispense setting number. After the required dispense volume is reached, press any of the up arrow keys. The display will show:

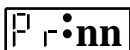

Where 'nn' is the currently selected dispense setting number. Use the up arrow keys to select a different location to store the dispense. Press the **'LEARN'** button or wait for the time out. A double beep will sound and the display will show:

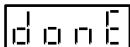

Press the **'Start'** button to immediately begin dispensing the learned dispense.

Tubing Calibration

Calibration mode fine tunes the dispense accuracy. Continued use of tubing will cause it to stretch and deform which creates dispensing errors. Also, differing viscosities and/or pumping speeds can also affect pumping accuracy.

Calibration uses the currently selected dispense program. Also, you will need a calibrated measuring cup to verify the actual dispense volume.

To begin calibration: While turning on power, press and hold the ‘LEARN’ key until the display shows:

L E r n

Press any up arrow key for the next Learn selection: Calibration:

C A L r

Press the ‘Start’ key to begin the dispense.

When the dispense is complete, the pump will stop, and the dispensed volume will be displayed with the volume units LED blinking.

Press the ‘LEARN’ key to accept this volume, or use the up arrow keys to enter a measured dispense volume.

Press ‘LEARN’ after the measured dispense volume has been entered and to store in memory.

The pump is now calibrated. Dispense volumes and pumping rates will be adjusted according to the measured volume entered.

Tubing Inside Diameter Setting

The default tubing inside diameter (ID) is set for the model NE-9000B pumping head to 3/16”.

If needed, the tubing inside diameter setting can be changed by entering Diameter Setting mode:

While turning on power, press and hold the ‘Diameter’ key until the display shows:

D I A

Press the ‘DIAMETER’ key again to select. The display will show the current diameter and the ‘Inches’ units LED will blink. While the units LED is blinking, use the up arrow keys to enter the new diameter as a fraction of an inch. For example, to enter 1/16” ID tubing, use the up arrow keys to change the display

to: **0 : 1 6**

Press the ‘LEARN’ key, or wait for the time out to enter the new setting. The tubing diameter will now be set to the new setting. The new diameter will be used as the current calibration setting.

Special Modes

Press and hold the ‘Diameter’/‘Setup’ key to access the Special Modes setup menu. The first mode, “Slow-Down” will be displayed:

S L O . n

Press the ‘LEARN’ key to move to the next mode, or wait for the time out. The following is the sequence of displays:

S L O . n

Slow Down mode, where ‘n’ is the current setting.

d r P . n

Anti-Drip mode, where ‘n’ is the current setting.

Dispense and pause mode, where 'n' is the current setting.

When pause mode is enabled, displays the pause setting.

Display secondary setup menu: Press any up arrow key to select.

Slow Down Mode

Setting: '0' = Disabled, '1' = Enabled.

Slow-Down mode prevents over dispensing when pumping a large volume at a high speed. When enabled, the pumping speed will ramp down as the volume dispensed approaches the target dispense volume.

Anti-Drip Mode

Setting: '0' = Disabled, '1' = Enabled.

When enabled, Anti-Drip mode will withdraw a small volume after the completion of a dispense to prevent dripping or oozing when the pump stops. The volume withdrawn is added to the next dispense.

Dispense, Pause, Repeat Mode

Setting: '0' = Disabled, '1' = Enabled.

When enabled, will create a more automated dispensing system, whereby the pump will continuously repeat the current dispense after a fixed time delay. The time delay will be displayed next:

Where 'nn' is the pause time in seconds. Use the arrow keys to change the dispense time.

Advanced Settings Menu

The "Other" menu selection provides access to the additional settings menu.

Table of Contents

1.	<u>GENERAL INFORMATION</u>	1
1.1	SAFETY	1
1.2	DISCLAIMER.....	2
1.3	WARRANTY	2
1.4	PACKING LIST.....	3
2.	<u>OVERVIEW</u>	3
2.1	GLOSSARY OF TERMINOLOGY AND CONCEPTS.....	3
3.	<u>SETUP</u>	5
4.	<u>LOADING PERISTALTIC TUBING</u>	6
4.1	REMOVE TUBING FROM PUMP.....	6
4.2	INSTALL NEW TUBING.....	7
5.	<u>PERISTALTIC TUBING</u>	8
6.	<u>USER INTERFACE</u>	8
6.1	ENTERING VALUES	8
6.2	LCD DISPLAY	8
6.3	LEDS	9
6.4	ARROW AND DECIMAL POINT KEYS	9
6.4.1	DECIMAL POINT KEY	10
6.5	‘DIAMETER’ AND ‘SETUP’ KEY.....	10
6.6	‘RATE’ AND ‘LEARN / PROGRAM PHASE #’ KEY	10
6.6.1	PUMPING RATE UNITS	10
6.6.2	PROGRAM ENTRY MODE OR DISPENSE SELECTION.....	11
6.7	‘VOLUME’ AND ‘PROGRAM FUNCTION’ KEY	11
6.7.1	CONTINUOUS PUMPING MODE.....	11
6.7.2	CLEARING “VOLUME DISPENSED”	11
6.7.3	VOLUME UNITS.....	11
6.7.4	PROGRAM ENTRY MODE	11
6.8	PUMPING DIRECTION KEY.....	11
6.9	‘START’/‘STOP’ KEY	12
6.10	DISPENSE SELECTION	12
6.11	‘PROGRAM PHASE #’ (NUMBER) KEY.....	12
6.12	‘PROGRAM FUNCTION’ KEY	12
6.12.1	PROGRAM PHASE FUNCTION PARAMETER	13
6.13	‘SETUP’ KEY.....	13
6.14	SPECIAL SETUP KEY	13
6.15	LEARN KEY	13
6.16	SPECIAL POWER-UP FUNCTIONS	13
6.16.1	FIRMWARE VERSION DISPLAY	13
6.16.2	RESET THE PUMP	13
6.16.3	LEARN AND CALIBRATE SELECTION	14
6.16.4	SPECIAL SETUP	14
6.17	ERROR AND ALARM MESSAGES.....	14
6.18	STATUS MESSAGES	15

7.	<u>OPERATION.....</u>	<u>16</u>
7.1	PERISTALTIC TUBE INSIDE DIAMETER	16
7.1.1	CHANGING VOLUME UNITS	16
7.2	STORED DISPENSE SELECTIONS	16
7.3	START/STOP TRIGGERS.....	16
7.4	OPERATING THE PUMP.....	17
7.5	PRIME AND PURGING.....	17
7.6	CHANGING THE PUMPING RATE AND DIRECTION WHILE PUMPING.....	17
7.7	VOLUME DISPENSED.....	17
7.8	RESUMING WHEN PAUSED.....	18
8.	<u>LEARN AND REPEAT</u>	<u>18</u>
9.	<u>CALIBRATION</u>	<u>19</u>
10.	<u>SETUP CONFIGURATION</u>	<u>19</u>
10.1	SLOW DOWN MODE	20
10.2	ANTI-DRIP MODE.....	20
10.3	DISPENSE, PAUSE, REPEAT MODE	21
10.4	ADVANCED SETTINGS MENU.....	21
10.5	POWER FAILURE MODE	21
10.6	AUDIBLE ALARM ENABLE	21
10.7	TTL I/O OPERATIONAL TRIGGER CONFIGURATION	21
10.8	TTL I/O DIRECTIONAL CONTROL INPUT CONFIGURATION.....	22
10.9	PUMP MOTOR OPERATING TTL OUTPUT CONFIGURATION	22
10.10	KEYPAD LOCKOUT	22
10.11	KEYPAD BEEP ENABLE	23
10.12	RS-232 PUMP NETWORK CONFIGURATION	23
10.13	SET TUBING INSIDE DIAMETER SETTING.....	23
10.14	SET DISPENSE MODE	24
10.15	SET PROGRAM MODE LOCKOUT	24
10.16	EXIT SPECIAL SETUP MENU	24
11.	<u>PUMPING PROGRAM.....</u>	<u>24</u>
11.1	HOW TO ENTER PUMPING PROGRAMS.....	24
11.1.1	PUMPING PROGRAM PHASE NUMBER	25
11.2	PUMPING PROGRAM EDIT FUNCTIONS.....	25
11.3	PROGRAM FUNCTION DESCRIPTIONS.....	26
11.3.1	'RATE': RATE FUNCTION	26
11.3.2	'INCR': INCREMENT RATE FUNCTION.....	26
11.3.3	'DECR': DECREMENT RATE FUNCTION.....	27
11.3.4	'STOP': STOP PUMPING OPERATION AND END THE PROGRAM.....	27
11.3.5	'JP:NN': JUMP TO PHASE.....	27
11.3.6	'PR:IN': PROGRAM SELECTION INPUT.....	27
11.3.7	'PR:NN': PROGRAM SELECTION LABEL	27
11.3.8	'LP:ST': DEFINE STARTING PHASE OF LOOP.....	28
11.3.9	'LP:EN': DEFINE CONTINUOUS LOOP END	28
11.3.10	'LP:NN': DEFINE LOOP END AND LOOP REPETITIONS	28
11.3.11	'PS:NN': PAUSE PUMPING.....	28
11.3.12	'IF:NN': JUMP TO PHASE IF EXTERNAL TRIGGER.....	29
11.3.13	'ET:NN': SETUP EVENT TRIGGER JUMP PHASE	29
11.3.14	'ES:NN': SETUP EVENT SQUARE WAVE TRIGGER JUMP PHASE.....	29
11.3.15	'ET:RS': EVENT RESET	29

11.3.16	'OUT.N': SET TTL OUTPUT PIN	29
11.3.17	'BEEP': BEEP.....	30
11.4	PUMPING PROGRAM EXAMPLES	30
11.4.1	EXAMPLE 1: 2 STEP RATE	30
11.4.2	EXAMPLE 2: REPEATED DISPENSES WITH SUCK BACK.....	30
11.4.3	EXAMPLE 3: RAMPING THE FLOW RATE.....	31
11.4.4	EXAMPLE 4: COMPLEX DISPENSES WITH EXTERNAL SYNCHRONIZATION	32
11.4.5	EXAMPLE 5: CONTROL FROM A HIGH-LOW PRESSURE SENSOR.....	33
11.4.6	EXAMPLE 6: AUTOMATED DISPENSING WITH SYNCHRONIZATION.....	34
11.4.7	EXAMPLE 7: SUB-PROGRAMS	35
11.4.8	EXAMPLE 8: DISPENSING WITH COMPLEX SYNCHRONIZATION.....	36
12.	<u>RS-232 COMMUNICATIONS.....</u>	38
12.1	CONNECTION AND NETWORKING	38
12.2	RS-232 PROTOCOL:	38
12.2.1	RS-232 GENERAL SYNTAX LEGEND.....	39
12.2.2	RS-232 PROTOCOL: BASIC MODE.....	40
12.2.3	RS-232 PROTOCOL: SAFE MODE	40
12.2.4	RS-232 PROTOCOL: BASIC AND SAFE MODE COMMON SYNTAX.....	41
12.2.5	NETWORK COMMAND BURST	41
12.3	COMMAND ERRORS AND ALARMS	42
12.4	RS-232 COMMAND SET.....	42
12.4.1	PROGRAM FUNCTION COMMANDS	43
12.4.2	PUMP OPERATIONAL COMMANDS	44
12.4.3	CONFIGURATION AND SETUP COMMANDS	45
12.4.4	GENERAL CONTROL AND STATUS COMMANDS.....	47
12.4.5	SYSTEM COMMANDS	48
12.5	GETTING STARTED WITH RS-232	48
13.	<u>LOGIC INTERFACE: TTL INPUT AND OUTPUT</u>	49
13.1	TTL I/O OPERATIONAL CONTROLS.....	50
13.2	TTL I/O CONTROL FROM THE PUMPING PROGRAM.....	51
13.3	TTL I/O CONTROL FROM RS-232	52
14.	<u>APPENDIX</u>	52
14.1	RS-232 COMMAND SUMMARY	52
14.2	RS-232 PUMP NETWORK CONNECTOR WIRING	54
14.3	ACCESSORIES	54
14.3.1	ANA-BOX.....	54
14.3.2	RS-232 NETWORK CABLES.....	54
14.3.3	AUTOMATION CABLE: DUAL PUMPS CONTROL CABLE.....	55
14.3.4	VALVE CONTROLLER.....	55
14.3.5	FOOT SWITCH.....	55
14.3.6	LOCKOUT DISABLE KEY	55
14.3.7	FIRMWARE UPGRADE	55
14.4	TROUBLESHOOTING AND MAINTENANCE	55
14.5	SPECIFICATIONS.....	56
14.5.1	MECHANICAL & ELECTRICAL.....	56
14.5.2	OPERATIONAL.....	56
14.6	CUSTOM APPLICATIONS	56
14.7	FLOW RATE LIMITS.....	57
14.8	TUBE CHEMICAL CHARACTERISTICS.....	57

1. General Information

Thank you for purchasing the New Era 9000 series Programmable Peristaltic Pump. With the New Era 9000 series peristaltic pump you will be able to perform simple fluid dispensing or implement a complex automated dispensing system.

Please familiarize yourself with the NE-9000's operation by reading this user's manual. For future reference, record the serial number, located on the rear of the pump, and the date of purchase.

Serial Number _____, Date of Purchase _____,

This Operating Manual, and the NE-9000's hardware, electronics and firmware are copyrighted.



Copyright 1999-2014, all rights reserved.

1.1 Safety

In the interests of safety, this pump and the tubing selected should only be installed and used by competent, suitably trained personnel after they have read and understood this manual, and considered any hazards involved.

Markings & Symbols

The following are the meanings of the markings and symbols used in these Safety Precautions.

-  **Warning** This symbol indicates information that, if ignored or applied incorrectly, creates the possibility of death or serious personal injury. i.e. fire, explosion.
-  **Caution** This symbol indicates information that, if ignored or applied incorrectly, possibility of minor or moderate personal injury or property damage.

Warning

- Read the user's manual
- This product is designed for liquid only.
- User is responsible to determine the suitability of the pump to its desired function.
- Verify that tubing is appropriate for liquid being pumped.
- Disconnect power from the pump when replacing tubing or connecting or disconnecting cables.
- Never leave any dangerous liquid inside of tubing when replacing tubing and disposing pump. Remaining liquid may cause serious injury.
- Never use in atmosphere with flammable gas.
- Never use in any location where there is a possibility of high humidity, high temperature, or extreme dust.
- Use only with the supplied power supply connected to a power source as specified on the power supply label.
- Never use a voltage that is different from voltage specified in this manual. Unless Authorized by NEW ERA PUMP SYSTEMS INC.
- Do not operate with any foreign matter (water, dirt, metal or other materials) inside the Pump-head.
- Do not push objects of any kind into the chassis openings, except for appropriate cables and connectors.
- Never try to take the unit apart or modify it except as described in this manual or authorized by NEW ERA PUMP SYSTEMS INC.. No user serviceable parts inside.
- Do not immerse the pump in liquid. If spilling occurs unplug pump immediately.
- Install on a stable surface.
- The pump can automatically start when the Pumping Program is operating or when attached to an external control device.
- Prevent liquids from entering openings in the rear of the pump.
- If the pump becomes damaged, do not use unless certified safe by a qualified technician. Damage includes, but is not excluded to, frayed cords and deterioration in performance.

ⓘ Caution

- Do not transport and store this product where the temperature and the humidity are high or fluctuate greatly, or the product is subjected to direct sunlight.
- Remove tubing from pump when not in use. Tubing will become deformed changing dispensed volume per rotation.
- Tubing wall may become permanently damaged if the roller compresses the same part of the tubing for a long time.
- During installation and use, be careful not to cut yourself on the edge of the Pump parts.
- Tubing life depends upon chemical and operating environment.
- Tubing Chemical compatibility list mentioned is only a guide. The user is responsible to determine the tubing compatibility to the chemical to be used.
- Keep delivery and suction lines as short as possible, use a minimum number of bends.
- Pump operates best at medium speeds. At very slow speeds pump will get hot. At high speeds pump and tubing life will decrease, pump will lose force/ pressure and may stall.
- Run at slow speed and use larger diameter tubing when pumping viscous liquid.
- User is responsible to determine the maximum speed the pump can operate.
- Discharge static from control cables before connecting by touching the cable to ground.
- Before touching the pump, discharge static by touching ground.

1.2 Disclaimer

NEW ERA PUMP SYSTEMS INC. makes no representations or warranties, expressed, statutory or implied, regarding the fitness or merchantability of this product for any particular purpose. Further, NEW ERA PUMP SYSTEMS INC. is not liable for any damages, including but not limited to, lost profits, lost savings, or other incidental or consequential damages arising from ownership or use of this product, or for any delay in the performance of its obligations under the warranty due to causes beyond its control. NEW ERA PUMP SYSTEMS INC. reserves the right to make any improvements or modifications to the product described in this manual at any time, without notice.

Design and specifications are subject to change without notice.

The information contained in this document is believed to be correct but NEW ERA PUMP SYSTEMS INC. accepts no liability for any errors it contains, and reserves the right to modify this document without notice.

NEW ERA PUMP SYSTEMS INC. products are not designed, intended, or authorized for use in applications or as system components intended to support or sustain human life, as a clinical medical device for humans, or for any application in which the failure of the product could create a situation where personal injury or death may occur.

All brand and product names used in this manual are the trademarks of their respective owners.

1.3 Warranty

NEW ERA PUMP SYSTEMS INC. warrants this product and accessories for a period of two year, parts and labor, from the date of purchase. The repaired unit will be covered for the period of the remainder of the original warranty or 90 days, whichever is greater.

The Peristaltic Pump Head Assembly and peristaltic tubing are considered replaceable items and are not covered under overall product warranty.

A return authorization number must be obtained from NEW ERA PUMP SYSTEMS INC. before returning a unit for repair. Warranty covered repairs will not be performed without a return authorization number. At the option of NEW ERA PUMP SYSTEMS INC., a defective unit will be either repaired or replaced.

This warranty does not cover damage by any cause including, but not limited to, any malfunction, defect or failure caused by or resulting from unauthorized service or parts, improper maintenance, operation contrary to furnished instructions, shipping or transit accidents, modifications or repair by the user, harsh environments, misuse, neglect, abuse, accident, incorrect line voltage, fire, flood, other natural disasters, or normal wear and tear. Changes or modifications not approved by NEW ERA PUMP SYSTEMS INC. could void the warranty.

The foregoing is in lieu of all other expressed warranties and NEW ERA PUMP SYSTEMS INC. does not assume or authorize any party to assume for it any other obligation or liability.

1.4 Packing List

Included with the NE-9000B Programmable Peristaltic Pump are the following items:



- One of the following external unregulated power supply adapters:
Input: One of: 120V AC 60 Hz, 220V AC 50 Hz, 240V AC 50 HZ,
or other custom specified power supply
Output: 24V DC @ 1A
- 4 feet of Norprene A-60-G[®] tubing.
- 4 tie wraps (2 assembled).
- 0.5oz sample of Super-Lube[®].
- This Operating Manual

2. Overview

The New Era 9000 Series is a general purpose single channel peristaltic pump capable of dispensing and withdrawal. It is controlled from a microcontroller based system which drives a step motor, allowing a wide range of pumping rates configured to the inside diameter of the peristaltic tube.

Features:

- ◆ Dispense and withdrawal pumping
- ◆ Pumping rates from 0.041 mL/min to 775.2 mL/min with a 3/16" ID tubing. Depending on tube characteristics.
- ◆ Dispense and withdrawal volumes separately accumulated.
- ◆ Programmable dispense volumes.
- ◆ Non-volatile memory of all operating parameters and Pumping Program.
- ◆ Programmable Phases allowing complex pumping applications and interaction with external devices.
- ◆ RS-232 bi-directional control.
- ◆ Built-in pump network driver. Pump network supports up to 100 pumps and other devices.
- ◆ Two modes of RS-232 computer control, Basic and Safe. Safe mode provides communication error detection, loss of communication detection, and automatic transmitting of alarm conditions.
- ◆ TTL I/O with firmware filtered control inputs to eliminate glitches and ringing on the control inputs.
- ◆ Configurable TTL operational trigger.
- ◆ Power Failure Mode: Restarts the Pumping Program after a power interruption.
- ◆ Audible Alarm.
- ◆ Many more features

2.1 Glossary of Terminology and Concepts

When a device has as many features as the NE-9000, understanding its operation could be a daunting task at first. By understanding the key concepts and terminology used in this manual, the operation of the NE-9000 will become quite intuitive. Every effort has been made to design the NE-9000 with a consistent and intuitive user interface.

To facilitate and enhance your understanding of the NE-9000's operation, please take the time to familiarize yourself with the basic concepts below:

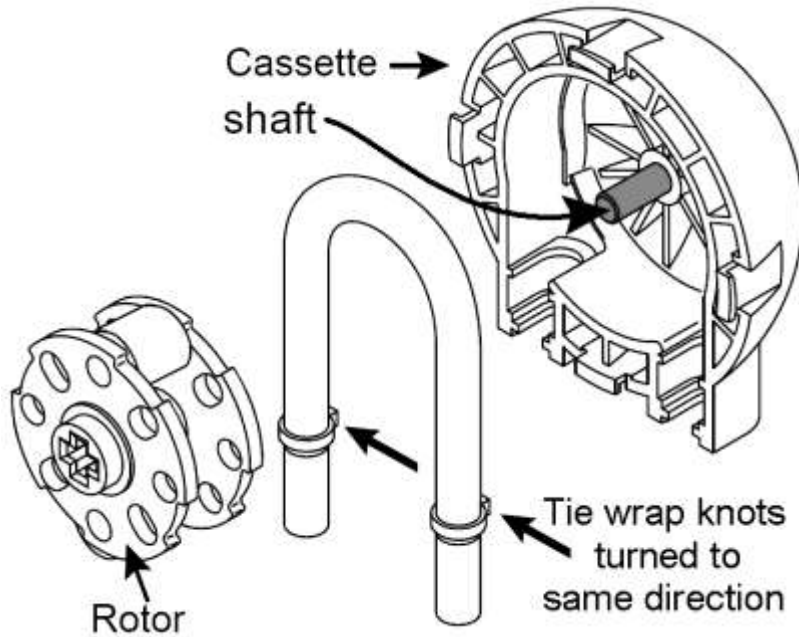
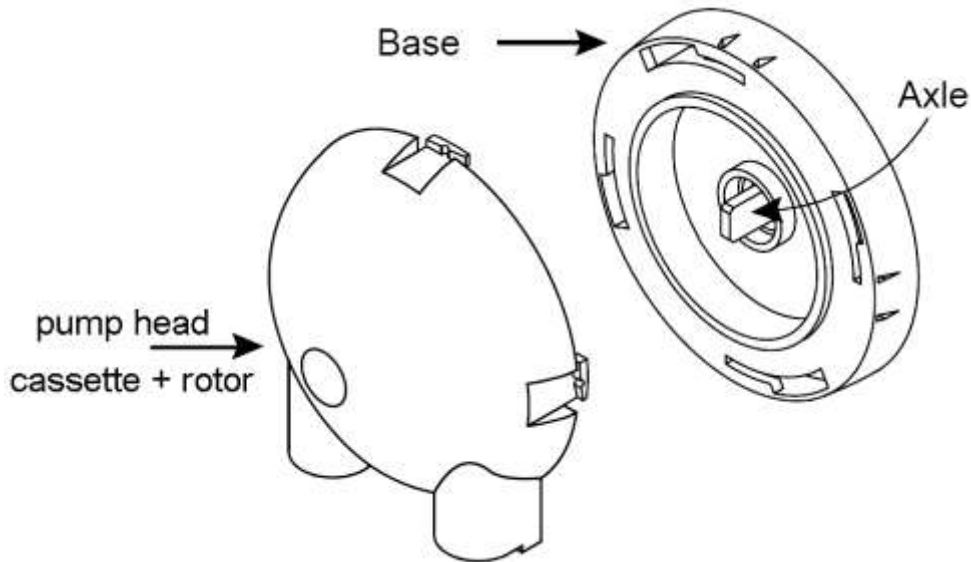

Fig 1. Pump Head Assembly



Terminology

Momentary Press:

A quick press, less than 1 second, then release of a key on the keypad.

Display Blink:

A momentary blanking of the LCD display. This indicates that the new data entered by the user is valid and has taken effect.

Program Entry Mode:

The mode where the Program Phase and Program function are selected and modified. In this mode the 'Program Phase #' and the 'Program Function' modes of the 'Rate' and 'Volume' keys are relevant.

Pumping Program:

The sequence of automated operations entered into the pump. This could be as simple as a single function to pump at a single dispensing rate continuously.

Pumping Program Operating:	When the pump is started with the ‘Start’/’Stop’ key, or any other source, the pump begins performing the operations in the Pumping Program until the Pumping Program either stops automatically or the pumped is stopped when the ‘Start/Stop’ key is pressed, or from any other source. While performing the operations defined in the Pumping Program, the Pumping Program is referred to as operating. While Operating, the motor can be pumping or stopped, according to the Pumping Program.
Pumping Program Stopped:	The motor is stopped and the pump is not operating the Pumping Program.
Pumping Program Paused:	The Pumping Program has been stopped, but can be resumed at the point where it was stopped.
Pumping Program Resumed:	Continuing a Pumping Program that was Paused before the completion of the Pumping Program. The Pumping Program continues at the point where the Pumping Program was stopped.
Executed:	The pump has performed a single operational Phase as defined in the Pumping Program.
Program Phase:	A single defined operation in the Pumping Program.
Phase Number:	A Program Phase’s numerical sequence location in the Pumping Program.
Currently Selected Function:	Each Pumping Program Phase instructs the pump to perform a particular operation. Only one Program Phase is selected at any one time. This is the current Phase. Each Phase is set to one function. The set function of the current Phase is the currently selected function.
Pumping Rate Function:	Each Pumping Program function instructs the pump to perform a particular operation. If the Phase’s operation instructs the NE-9000 to pump, then associated with that Phase is the Phases’ pumping information. When ‘Program Entry Mode’ is exited, the ‘Rate’, ‘Volume’, and pumping direction keys refer to the currently selected Program Phase’s function. The Program functions that are associated with pumping information are referred to as Pumping Rate functions.
Function Parameter:	Certain functions, which do not instruct the NE-9000 to pump, require additional data. This additional data, displayed with the function, is the function’s parameter.
Start Trigger:	The Pumping Program may be started, or stopped, from multiple sources. These are the keypad’s ‘Start’/’Stop’ key, the TTL I/O ‘Operational Trigger’ input, or from a command received through the RS-232 connection.

3. Setup

- ◆ Place the pump on a stable surface.
- ◆ Plug the round connector end of the supplied power supply adapter into the power plug located on the lower right of the pump’s rear. See section 13, Logic Interface: TTL Input and Output, for a diagram of the rear of the pump. Plug the other end of the power supply adapter into an appropriate electrical outlet. The pump will be powered when the bottom of the power switch, located on the upper right of the rear of the pump, labeled ‘1’, is pressed. The red indicator on the switch is visible when the power switch is in the ‘on’ position. After power is applied to the pump, the pump’s display will flash.
- ◆ Next the Pumping Program can be entered. Before the Pumping Program can be operated, the pump needs the measurement of the peristaltic tube inside diameter. The peristaltic tube inside diameter can be entered using the keypad. Refer to ‘Diameter’ and ‘Setup’ Key. The default setting is 3/16” tubing

- ◆ When pumping viscous liquids, place the reservoir above the height of the pump.
- ◆ Finally, the peristaltic tube can be loaded and the pump started.

4. Loading Peristaltic Tubing

⚠ **Remove tubing from pump when not in use. Tubing will become deformed changing dispensed volume.**

4.1 Remove Tubing from Pump

4.1.1. Remove liquid from tubing.

- 1) Turn on power to the Pump.
- 2) Press and hold Start/Stop and purge out fluid in Tubing.
- 3) Remove tubing from liquid.
- 4) Turn off power to the pump.

⚠ Warning: Liquid will siphon through tubing when it is removed from pump.

⚠ Warning: Dangerous Liquid in the tubing may cause injury.

4.1.2. Uninstall Cassette

Turn Cassette counterclockwise until it stops. Then pull it out.

4.1.3. Remove Tubing

1. Remove one side of peristaltic tubing from Cassette.
2. Pull out Tubing. Hold rotor from falling.
3. Remove the other side of tube from Cassette.

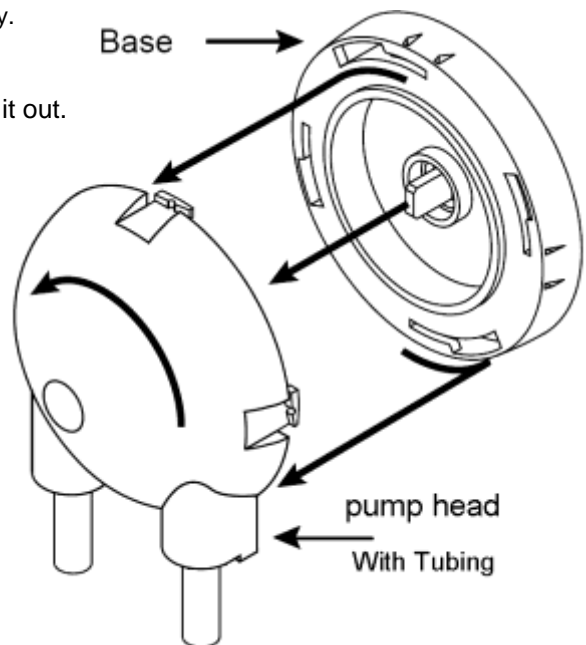

4.2. Install New Tubing

4.2.1. Prepare New Tubing

- 1) Wrap 2 tie wraps 5 3/8" apart (136 millimeters apart) on the new Tubing.
Tie wrap knots facing the same direction

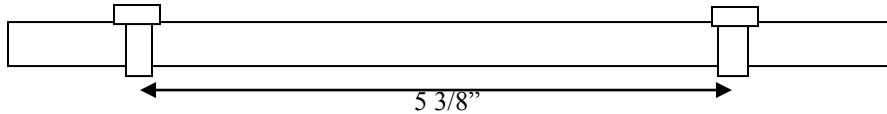

4.2.2. Install New Tubing

- 2) Remove Rotor
- 3) Add grease to the Cassette shaft and the surface of New Tubing.
(See gray area below)
- 4) Return Rotor to shaft of Cassette.
- 5) With both knots of the tubing facing the Cassette install one knot into the guide.
- 6) Pull out the Rotor a little bit and place Tubing between the Cassette and the Roller.
- 7) Install the other knot into the guide.

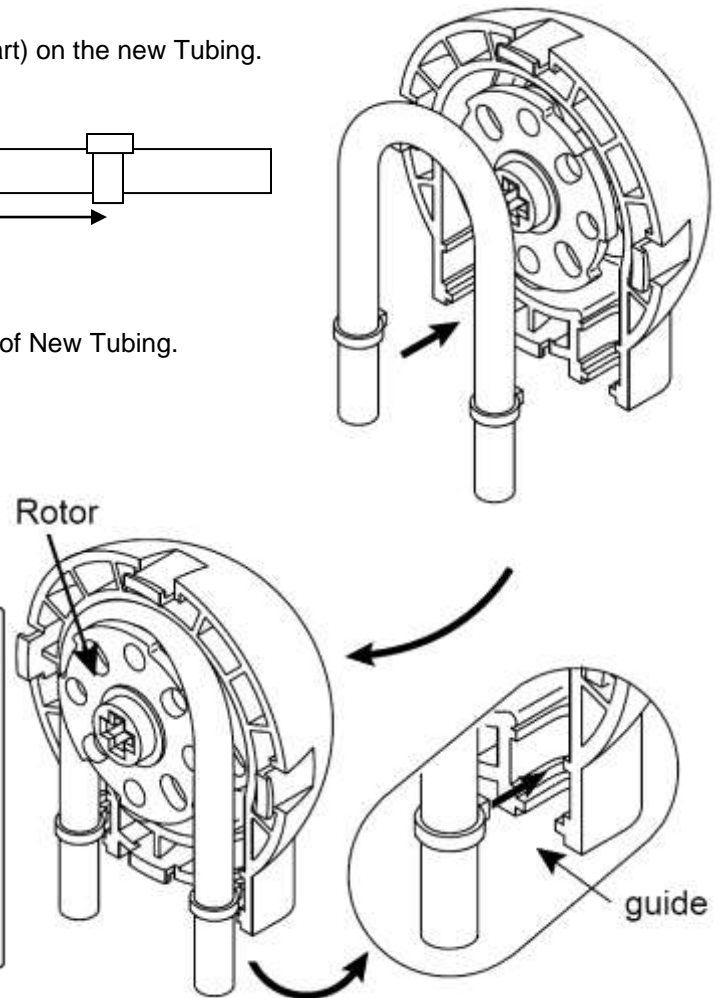
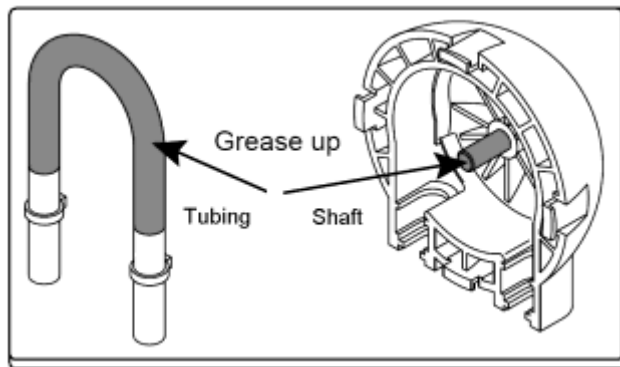

4.2.3. Install Cassette to Base

- 1) Rotate Rotor so that it fits into axle.
- 2) Attach Cassette onto Base of Pump by placing (a) into (b).
- 3) Turn Cassette clockwise until it stops.
Verify that each indent of the Cassette is matched perfectly with each marking on the Base of Pump.
- 4) Prime Pump before Starting Dispense Cycle.

⚠ Warning

Be careful not to be cut or injured by the edge of the Pump parts.

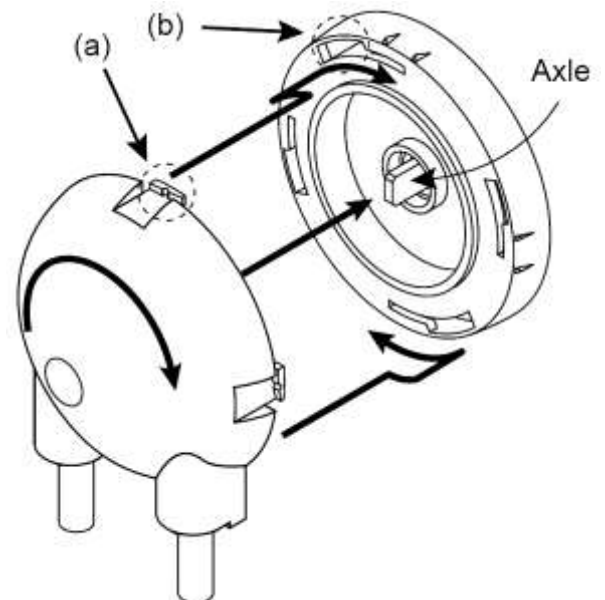

5. Peristaltic Tubing

Refer to last section of this Manual for tubing recommendations.

If you intend to use a long extension of tubing it is recommended that you (move the segment) change the segment that is used in the pump regularly.

Be aware that the tubing will wear out because of friction. The rotating mechanism will also wear out because of friction. Always lubricate rollers, shaft and tubing.

6. User Interface

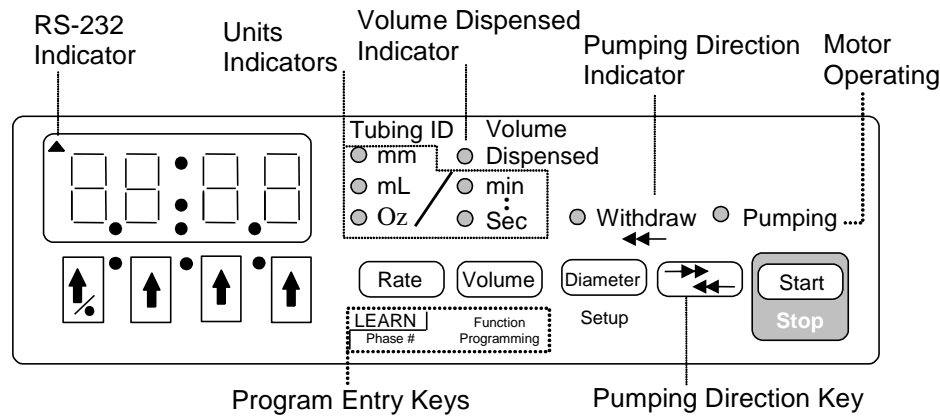

Figure 1: Front Panel

6.1 Entering Values

When applicable, values can be changed by either displaying the current value, then using the arrow keys, or from a computer connected to the pump. The new value will be stored in the pump's non-volatile memory, meaning that the new value will not be lost the next time that power is applied to the pump. The only exception is when the pumping rate is changed from an attached computer while the Pumping Program is operating. In this case the new pumping rate will not be stored in non-volatile memory.

A displayed value can be changed by pressing the arrow keys below each digit. If the value to be changed is not currently displayed, when applicable, press the key associated with the required value. The display will show the setting's current value and its units, if any.

While the current value is being changed, the units LEDs associated with the value, if any, will blink. Except where noted, the new value is stored, and/or the selected operation takes effect, when either

- 1) A non-arrow key is pressed, or
- 2) After a 2 second delay since the last arrow key was pressed

If the new value is valid and different from the original value, the display will blink, indicating that the new value was stored. Otherwise, if the value was invalid, an error message will be displayed. Pressing any key clears the error message and restores the original value.

In general, if a parameter has 2 values, 'off' and 'on', they are represented by the numbers '0' and '1', respectfully.

6.2 LCD Display

The display consists of a 4 digit reflective LCD (Liquid Crystal Diode) display. This is the general purpose user display device for displaying numerical data, functions and parameters. The colon (:) is used for displaying time or for separating function abbreviations from their parameter values. In the upper left corner is a triangle that indicates valid reception of RS-232 remote communications.

6.3 LEDs

To the right of the LCD are 8 red, round, LED (Light Emitting Diode) indicators. The first 2 columns display the units of the displayed values. Units are expressed using 1 or 2 LEDs. For instance, 'mL/ Sec' is expressed by lighting the 'ml' and the 'Sec' LEDs.

'**Dispensed**' indicates that the displayed volume is the total 'Volume Dispensed' or pumped.

When '**Pumping**' is lit (not blinking), the motor is operating, either dispensing or withdrawing. If blinking, the motor is not operating, and the Pumping Program is paused. When the pump is restarted, the Pumping Program will resume at the point where the Pumping Program was interrupted. When not lit (not blinking) the pump is stopped, but the Pumping Program may be operating a pause Phase. Starting the pump, when the Pumping Program is stopped, will start the Pumping Program from the beginning (Phase 1).

'**Withdraw**' indicates that the pumping direction is set for withdrawing. If not lit, then the pumping direction is set for dispensing. Also, the 'Withdraw' LED indicates that the "Volume Dispensed" refers to the volume withdrawn. If not lit, the "Volume Dispensed" refers to the volume dispensed.

LED	Description
Inches	Tubing inside diameter in inches
mL	Milliliters
min	Minutes
Oz	Ounces
sec	Seconds
Dispensed	Volume dispensed displayed
Withdraw ←←	Pumping Direction: Lit: Withdraw Not lit: Dispense
Pumping	Lit: Motor is operating Blinking: The Pumping Program is paused Not lit: The Pumping Program is stopped or executing a pause Phase

Pumping rate units are expressed using 2 LEDs:



6.4 Arrow and Decimal Point Keys

Each of the four digits in the display is associated with the up arrow key directly below it. When applicable, the arrow key is used to increment the value of that digit, or advance to the next selection in a list of functions or settings.

Each press of an up arrow key will increase the digit by 1, up to 9, and then back to 0. The arrow keys may also be held down for continuous incrementing of numbers. Some parameters, such as the RS-232 baud rate, scroll through a selection of values when the arrow keys are pressed. Other parameters have a fixed range of values, such as some setup parameters that are either turned on or off. In these cases, the arrow key will only scroll up to the maximum value for that parameter, then back to the minimum value.

When changing the pumping rate units, each press of any arrow key will change the units LEDs to the next units selection.

When the display blinks, the new value is stored and takes effect. This will occur when a non-arrow key is pressed or after a 2 second delay since the last key press.

6.4.1 Decimal Point Key

There are 4 decimal point positions on the LCD display. Each decimal point position is to the right of a digit in the display. The last decimal point position, to the right of the right-most digit is not displayed, indicating whole numbers with no decimal point.

To move the decimal point, simultaneously press the 2 up arrow keys under the 2 digits next to the decimal point position. Press the same 2 up arrow keys to clear the decimal point, to display a whole number.

Alternatively, to move the decimal point position, use the left-most arrow key / decimal point key (\leftarrow/\odot). Press and hold this key for at least 1 second and wait until the left-most digit scrolls past '9' to '0'. While continuing to hold this key, the decimal point will shift 1 position to the right. After the right-most decimal point position, the decimal point will shift to the first decimal point position. Release the key when the decimal point is in the required position.

6.5 'Diameter' and 'Setup' Key

The 'Diameter' key allows the peristaltic tube inside diameter to be viewed and set. While being displayed, the 'Tubing ID Inches' LED is lit. The diameter can be changed by holding the 'Diameter' key while turning on power, then selecting 'DIA'.

If the 'Diameter' key is pressed and held, 'Setup' mode will be entered. (see sec. 6.13, 'Setup').

When the Pumping Program is operating, pressing this key will display the current peristaltic tube diameter for review. When the key is released, the display returns to its previous display.

The diameter is displayed as a fraction: 03:16 indicates 3/16" ID tubing.

6.6 'Rate' and 'Learn / Program Phase #' Key

When the Pumping Program is stopped, except in "Program Entry Mode", the 'Rate' key allows the pumping rate to be viewed or changed. If the currently selected function allows selection of rate units, momentarily pressing this key will switch between the 'Rate' display and the select rate units mode.

To change the pumping rate displayed, use the arrow keys.

While the Pumping Program is operating, pressing this key will display the current pumping rate, if applicable. After the key is released, the pumping rate will continue to be displayed for 2 seconds. While displayed, the current pumping rate can be changed by pressing the arrow keys. The rate units will blink while the rate is being changed. The new pumping rate takes effect when the display blinks after a 2 second delay or when a non-arrow key is pressed. The new pumping rate is stored in the current Program Phase.

A pumping rate of 0.0 will stop the pump. When the pumping rate is changed, if it is out of range of the

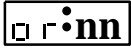
pumping rate limits, the display will show , where 'nn' indicates the currently selected Phase Number. Pressing any key clears the message and returns to the previous pumping rate. See section 14.7, "Flow Rate Limits", for a list of minimum and maximum pumping rates.

6.6.1 Pumping Rate Units

The pumping rate units can only be changed when the Pumping Program is not operating. If the currently selected function allows selection of rate units ('RATE' function), a momentary press of the 'Rate' key will enter Rate Units Change mode. The 2 LEDs representing the units will blink and the display will

show: .

Each press of any arrow key selects the next rate units, as indicated by the blinking units LEDs. When the required rate units are blinking, press any non-arrow key or wait 2 seconds. The display will blink, indicating the rate units are stored. The rate units are stored in the currently selected Program Phase. The rate units can be independently set for each Phase with a 'RATE' function.

6.6.2 Program Entry Mode or Dispense Selection

While the Pumping Program is stopped, pressing and holding the 'Rate' key will enter "Program Entry Mode" or "Dispense Selection Mode".

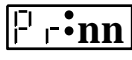
If Dispense mode is enabled, the display will show the currently select dispense: 

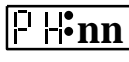
Otherwise, the current Program Phase number is displayed: 

'nn' indicates the currently selected dispense or Program Phase.

A momentary press of the Rate or Volume key will exit return to the rate or volume display.

6.7 'Volume' and 'Program Function' Key

Except in "Program Entry Mode", momentary presses of this key will switch the display between the "Volume to be Dispensed" and the "Volume Dispensed" displays, as indicted by the "Volume Dispensed" LED.

With the Pumping Program stopped, the "Volume to be Dispensed" can be changed. The new value is stored in the current Program Phase or selected dispense.

6.7.1 Continuous Pumping Mode

To disable the "Volume to be Dispensed" (continuous pumping), set the "Volume to be Dispensed" to 0.0.

After entry, the display will show , indicating the "Volume to be Dispensed" is off. In this mode, the pump will not stop at a set volume and will pump continuously until the pump is stopped, or an "event trigger", programmed into the Pumping Program, occurs.

Pressing any arrow key will change the display back to 0.0. The "Volume to be Dispensed" can now be set.

6.7.2 Clearing "Volume Dispensed"

With the Pumping Program stopped, display the "Volume Dispensed". Then pressing and holding any up arrow key for one second will clear the dispense and withdrawal dispensed volumes to 0.

6.7.3 Volume Units

With the Pumping Program stopped, and the "Volume Dispensed" displayed, as indicated by the Dispensed LED, the volume units can be changed. Momentarily press any up arrow key. The display will

show  and the volume units will blink.

Press any up arrow key to change the volume units. Wait for the time out or press any non-arrow key to enter the setting.

NOTE: Changing the volume units changes the units for all dispenses and Program Phases.

6.7.4 Program Entry Mode

While the Pumping Program is stopped, pressing and holding the 'Volume' key will enter "Program Entry Mode" or "Dispense Selection Mode".

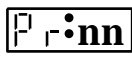
If Dispense mode is enabled, the display will show the currently select dispense: , where 'nn' indicates the currently selected dispense. Otherwise, "Program Entry Mode" is entered as indicated by the

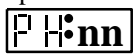
Program Phase number display: , where 'nn' indicates the current Program Phase number.

A momentary press of the Rate or Volume key will return to the rate or volume display.

6.8 Pumping Direction Key

The pumping direction key, '' , changes the direction of pumping. Pressing this key switches the pumping direction between 'dispense' and 'withdraw', as indicated by the 'Withdraw' LED. When the

LED is lit, the pumping direction is 'withdraw', otherwise the pumping direction is 'dispense'. The new pumping direction is stored in the current Program Phase.

The "Volume Dispensed" is accumulated separately for dispense and withdrawal. When the pumping direction is changed, the current "Volume Dispensed" is also changed accordingly between the dispense and withdrawal "Volume Dispensed" accumulations.

When the Pumping Program is operating and the "Volume to be Dispensed" is non-zero, the pumping direction cannot be changed. Otherwise, when pumping continuously ("Volume to be Dispensed" disabled), the pumping direction can be changed.

6.9 'Start'/'Stop' Key

The 'Start/Stop' key starts or stops the Pumping Program's operation. Pressing this key switches between the Pumping Program operating and the Pumping Program paused. When the 'Start/Stop' key is pressed before the completion of a Program, the motor is stopped and the Pumping Program will be paused. The 'Pumping' LED will then blink, indicating that the Pumping Program is paused.

Pressing this key again will resume the Program at the point it was paused. If any other key is pressed while the Pumping Program is paused, the Pumping Program will be stopped and reset. Pressing the 'Start/Stop' key will then start the Pumping Program from the beginning (Phase 1).

Pressing and holding this key while starting the Pumping Program will start the prime/purge mode. Purge will begin after the key is held for one second, and continue until the key is released. The pump will stop after the key is released.

6.10 Dispense Selection

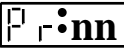
When in Dispense Mode, pressing and holding either the Rate or Volume keys will enter "Dispense Selection Mode". The display will show: , where 'nn' is the current dispense selection.

To change the current Dispense Selection, press the up arrow keys below the Dispense Selection's digits. The maximum Dispense number is 40. To reset to Dispense number 1, press and hold either the Rate or Volume keys until Dispense number is 1.

Momentarily press the Rate or Volume keys to exit Dispense Selection Mode.

6.11 'Program Phase #' (Number) Key

When in the "Program Entry Mode", momentary presses of the 'Program Phase #' and the 'Program Function' keys switch between the Program Phase number and the Program Function displays. The

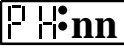
Program Phase number will be displayed as , where 'nn' is the current Program Phase number.

When the Program Phase number is displayed and the current Phase's function is a rate function, a momentary press of the 'Program Phase #' key exits 'Program Entry Mode', and displays the pumping rate.

To change the current Program Phase number, press the up arrow keys below the Phase number's digits. The maximum Phase number is 40. To reset to Phase number 1, press and hold the 'Program Phase #' key until the Phase number is 1.

When a new Program Phase number is selected, the current value of all settings will be that of the currently selected Program Phase.

6.12 'Program Function' Key

When in the "Program Entry Mode", momentary presses of the 'Program Phase #' and the 'Program Function' keys switch between the Program Phase number and the Program Function displays.

With the Program Phase function displayed, the Program Function can be selected. Pressing any arrow key, or an arrow key to the left of the colon (:) or decimal point (.) if displayed with the function, will select the next Program Function. The selected function is stored by either pressing any non-arrow key, or

after a 2 second delay. If the selected function is different than the original function, the display will blink when the selected function is stored.

6.12.1 Program Phase Function Parameter

If the selected function has a parameter associated with the function, the value of the parameter will be displayed to the right of the function name, separated by either a period (.) or a colon (:).

To change the parameter's value, press the arrow keys below the parameter's digits. The parameter's new value is stored by either pressing any non-arrow key or after a 2 second delay. If the parameter has changed from its original value, the display will blink when the parameter's new value is stored.

6.13 'Setup' Key

The secondary function of the 'Diameter' key is 'Setup'. While the Pumping Program is not operating, press and hold the 'Diameter' key until the first setup configuration parameter, "Slow Down Mode", is

displayed: 

The display will consecutively display, for about 2 seconds, each Setup Configuration parameter and its current setting. Pressing any non-arrow key will immediately advance to the next Setup Configuration parameter.

To change a Setup Configuration parameter, press an arrow key under the parameter's value. To store the new value, press any non-arrow key or wait 2 seconds. If the parameter value differs from its previous value, the display will blink. The new parameter value will be stored and the next parameter will be displayed. See section 10, "Setup Configuration" for a complete description of the Setup Configurations.

After the last configuration parameter is displayed, the display reverts back to displaying the peristaltic tube diameter. Any new parameter value will take effect immediately upon being stored.

6.14 Special Setup Key

While turning on power to the pump, press and hold the 'Setup' key to access the special setup menu. The

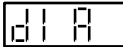
first menu entry "Set Tube Diameter" will be displayed: 

6.15 Learn Key

While turning on power to the pump, press and hold the 'Learn' key to access the Learn mode menu. The

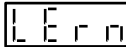
first menu entry "Learn and Repeat" will be displayed 

6.16 Special Power-Up Functions

The following special functions are accessed by pressing the relevant key, **while** turning on power to the pump.

6.16.1 Firmware Version Display

To display the pump's firmware version, press the **left-most up arrow key** (↑/●) while turning on

power to the pump. The display will show: , where 'n.nn' is the firmware version number. Pressing any key will clear the display.

6.16.2 Reset the Pump

To reset the pump, press the **right-most up arrow key** (↑) while turning on power to the pump. The

display will show . Pressing any key will clear the display.

With a pump having as many complex features as the NE-9000, it is easy for a novice user experimenting with the pump's setup to get the pump into a 'weird' state. Performing this reset function will bring the pump out of a 'weird' state.

6.16.3 Learn and Calibrate Selection

Pressing the 'Rate'/'LEARN' key while turning on power to the pump will display the Learn selection menu. Use the up arrow keys (↑) to scroll through the selections. Press a non-arrow key or wait for the time out to select.

LEARN

Learn and Repeat Dispense

CALR

Tubing calibration

done

Exit without making any selection.

6.16.4 Special Setup

Pressing the 'Diameter'/'Setup' key while turning on power to the pump will enter the Special Setup selection menu. Use the up arrow keys (↑) to scroll through the selections. Press a non-arrow key or wait for the time out to select.

DIR

Set Tubing Inside Diameter

DISP

Set Dispense Mode

PLoC

Set Program Mode Lockout

done

Exit without making any selection

6.17 Error and Alarm Messages

If the value entered is beyond the pump's capabilities or is invalid, or an operational problem occurred, one of the following error or alarm messages will be displayed:

OOR

Value entered is 'Out Of Range' of the pump's operational limits.

OOR:nn

An out of range error occurred at Pumping Program Phase number 'nn', or the value just entered is out of range. Check the pumping parameters and peristaltic tube diameter.

Err:nn

A Pumping Program error was encountered at Pumping Program Phase number 'nn'. The indicated Phase is invalid in the context of the entire Pumping Program.

Key pressed is not currently applicable.

r232

A communications time-out alarm occurred with an attached computer while operating in the "Safe Communications Mode". This most likely indicates that the RS-232 cable was detached or the communication program on the computer has ended without turning off "Safe Communications Mode".

Err.n

An error was detected during power up, where 'n' indicates the error. If n=1, then the values stored in the pump's non-volatile memory were invalid and were reset. If n=2, then the non-volatile memory may need to be replaced.

LoC-

Pump settings are locked out from the keypad. The lockout key is needed to change settings. Lockout can also be reset with the reset function.

6.18 Status Messages



Indicates pumping rate units change mode. The units LED's will also be blinking.



Indicates that the Pumping Program has paused and is waiting for the user to press 'Start', or for an external operational trigger, to continue.



Indicates that the pump is busy completing a long operation.



Indicates that the "Volume to be Dispensed" is 0.00, and is turned off. This is the continuous pumping mode.



Indicates that the pump is purging. Displayed while holding down the 'Start/Stop' key.

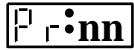

Indicates either the Dispense Mode dispense number selection, or a Pumping Program is waiting for the user to select a sub-program.

7. Operation



Before the pump can be operated, the pumping data must be setup. At minimum, the peristaltic tube inside diameter and a non-zero pumping rate needs to be set. The operation of the pump can then be started from the keypad, TTL I/O connector, or from RS-232 control. From the keypad, pressing the 'Start / Stop' key will start the pump operation.

7.1 Peristaltic Tube inside Diameter

The peristaltic tube inside diameter can only be set from the Special Setup mode selected while turning on power with the Diameter key. Use the arrow keys to set the diameter value. While the diameter value is being set, the 'Tubing ID Inches' LED will blink. The new diameter value is stored after pressing any non-arrow key, or after a 2 second delay. The default setting is 3/16" tubing.

Any diameter setting under 1" can be entered. If the diameter is out of this range, the display will show [oor]. Pressing any key restores the diameter display to its previous value. Changing the diameter *will not zero any current settings*.

7.1.1 Changing Volume Units

The volume units used for accumulated volumes and the "Volume to be Dispensed" settings can be changed to either 'mL' or 'Oz'. **NOTE:** A change in the volume units will affect all "Volume to be Dispensed" settings in the Pumping Program.

Display the "Volume Dispensed" by press and releasing the "Volume" key until the "Dispensed" LED is lit. Pressing any up arrow key will change the display to  and the current volume units will blink.

Then, press any up arrow key to switch the volume units between 'mL' and 'Oz'. Press any non-arrow key or wait 2 seconds to enter the new volume units. The display will blink when entered. The selected volume units will be stored in memory.

7.2 Stored Dispense Selections

In Dispense Mode, multiple dispense settings can be stored and selected as needed. The last selected dispensing program will be the default dispense program when the pump is powered on. Up to 40 dispense settings can be stored.

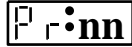
To view the currently selected dispense number or to select a different dispense number, press and hold either the 'Rate' or 'Volume' key. The display will show: 

Where 'nn' indicates the currently selected dispense number. Use the up arrow keys to change the dispense selection number. Press 'LEARN' to select, or wait for the time out. The display will blink when the selection is entered.

Press the 'Start' key to immediately start the selected dispense.

Press the 'Rate' or 'Volume' keys to display the settings for the selected dispense. Any changes made to the pumping rate or dispense volume will be stored in the selected dispense program.

7.3 Start/Stop Triggers

The Pumping Program can be started or stopped from any of the three sources: The keypad 'Start/Stop' key, RS-232 'RUN' command, or the TTL I/O Operational Trigger input. Each can control the Pumping Program's operation.

7.4 Operating the Pump

When the “Start/Stop” key is pressed, the Pumping Program begins to operate. In Dispense Mode, the currently selected dispense will begin. If Dispense mode is off, the Pumping Program will begin, starting with Phase 1. If the current Program Phase specifies a pumping rate, the pump will begin pumping, and the ‘Pumping’ LED will be lit.

The pumping direction will depend on the selected direction. The display will show the “Volume Dispensed” with a volume units LED (‘mL’ or ‘Oz’) and the ‘Dispensed’ LED lit.

While pumping, the pump will pump continuously in the current Program Phase, unless a “Volume to be Dispensed” is set, or an Event trigger is set. If a “Volume to be Dispensed” is set, the Program Phase will be complete after the set volume has been dispensed or withdrawn, measured from the start of the Phase.

Pressing the ‘Volume’ or ‘Diameter’ keys will display the current “Volume to be Dispensed” or the diameter setting while the key is held.

7.5 Prime and Purging

To prime/purge, with the Pump stopped, press and hold the ‘Start/Stop’ key. The Pump will start, then, after one second, prime/purge will begin. The pump will pump at its top speed in the currently set direction. Purging will continue until the ‘Start/Stop’ key is released. Then the pump will stop. While

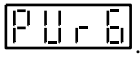
purging the display will show: .

7.6 Changing the Pumping Rate and Direction While Pumping

Except with some complex Pumping Programs, the pumping rate can be changed while the pump is operating. To change the pumping rate, momentarily press the ‘Rate’ key. While the pumping rate is displayed, press the up arrow keys to change the rate. The rate units will blink while the rate is being changed. If the up arrow keys are not pressed, the display will return to the “Volume Dispensed” display after a 2 second delay. Rate units cannot be changed while pumping.

The new rate is stored after a 2 second delay or by pressing a non-arrow key. If the new rate is within the operating range of the pump, the display will blink and the new rate will be stored in the current Program Phase and the pump begins pumping at the new rate. If the new rate is out of the operating range of the

pump, the display will show . Pressing any key clears the error message.

The pumping direction can be changed while pumping if the “Volume to be Dispensed” is 0.0 (off). Pressing the direction key will immediately change the pumping direction and store the pumping direction in the current Program Phase. Also changing the pumping direction changes the accumulated “Volume Dispensed” according to the new pumping direction.

7.7 Volume Dispensed

While pumping, the display will show the total accumulated volume pumped with the ‘mL’ or ‘Oz’ LED lit and the ‘Dispensed’ LED lit. Volume is computed based upon the inside diameter setting.

The volume is accumulated separately for dispense and withdrawal. When the pump changes direction, the “Volume Dispensed” changes to the accumulated volume for the current pumping direction.

The “Volume Dispensed” accumulations, for dispense and withdrawal, are **reset to 0** when:

- A) Pressing and holding any arrow key while displaying the “Volume Dispensed”.
- B) A sub-program is selected when the Pumping Program executes a Program Selection function.
- C) The diameter is changed.
- D) From the RS-232 clear “Volume Dispensed” command (CLD).
- E) The accumulated Volume Dispensed rolls over from 9999 to 0.

F) The pump is powered on.

When the Pumping Program is stopped, and the display shows the Program function or pumping rate information, the accumulated Volume Dispensed can be displayed by pressing the 'Volume' key one, two, or three times, depending on the current display.

7.8 Resuming When Paused

If the Pumping Program is stopped before the completion of the Pumping Program, the 'Pumping' LED will blink, indicating that the Pumping Program is paused. While the 'Pumping' LED is blinking, starting the pump again will resume the Pumping Program where it was stopped. This means that the Pumping Program will continue at the point in the Phase where it was stopped and the 'Volume to be Dispensed' will still be referenced from when the Program Phase first started.

Pressing any key other than the 'Start' key will cancel "Pumping Program paused" and the 'Pumping' LED will stop blinking. When the Pumping Program is started again, it will start from the beginning (Phase 1).

8. Learn and Repeat

"Learn and Repeat" easily teaches the pump a dispense volume. Then you can immediately repeat this dispense. Dispense Mode must be set to repeat a dispense.

While turning on power, press and hold the 'LEARN' key. The display will show:

The display shows the characters 'L', 'E', 'r', and 'r' in a row, indicating the 'Learn and Repeat' mode is active.

Press and hold the 'Start' key to begin dispensing. As the desired volume is approached, you can release the key to stop the pump, then periodically press the 'Start' key to slowly and accurately approach your dispense volume.

While pumping, the volume dispensed will be displayed. When the 'Start' key is released, the display will alternate between displaying the volume dispensed and the currently selected dispense setting number.

Press the 'LEARN' key, or wait for the time out, to immediately store the dispensed volume in the currently selected dispense setting. A double beep will sound and the display will show:

The display shows the characters 'd', 'o', 'n', and 'E' in a row, indicating the learned volume is stored.

Press any key to return to the currently selected dispense program display. Press 'Start' to immediately begin the newly learned dispensed.

Storing in a different dispense selection number

The learned dispense can be stored in a different dispense setting number. After the required dispense volume is reached, press any of the up arrow keys. The display will show:

The display shows the characters 'P', 'r', a dot, and 'nn' in a row, indicating the learned volume is stored in a different dispense setting number.

Where 'nn' is the currently selected dispense setting number. Use the up arrow keys to select a different location to store the dispense. Press the 'LEARN' button or wait for the time out. A double beep will sound and the display will show:

The display shows the characters 'd', 'o', 'n', and 'E' in a row, indicating the learned volume is stored in the selected dispense setting number.

Press the 'Start' key to immediately begin dispensing the learned dispense.

9. Calibration

Calibration mode fine tunes the dispense accuracy. Continued use of tubing will cause it to stretch and deform which creates dispensing errors. Also, differing viscosities and/or pumping speeds can also affect pumping accuracy.

Calibration uses the currently selected dispense setting, or the first pumping rate in the Pumping Program. Otherwise, the calibration defaults to 250 mL at 500 mL/min. Also, you will need a calibrated measuring cup to verify the actual dispense volume.

To begin calibration: While turning on power, press and hold the ‘LEARN’ key until the display shows:

L E a r n

Press any up arrow key for the next Learn selection: Calibration:

C A L r

Press the ‘Start’ key to begin the dispense.

When the dispense is complete, the pump will stop, and the dispensed volume will be displayed with the volume units LED blinking.

Press the ‘LEARN’ key to accept this volume, or use the up arrow keys to enter a measured dispense volume.

Press ‘LEARN’ after the measured dispense volume has been entered.

The pump uses the entered volume to recalibrate the pumping rate and dispense volume.

Changing the tubing diameter or resetting the pump will cancel the entered calibration. The pump will use the tube diameter as the calibration value.

10. Setup Configuration

To change or view the setup configuration, the Pumping Program must be stopped. Press the ‘Diameter’/‘Setup’ key until the first parameter, ‘SLO.n’ is displayed. After 2 seconds, or when any non-arrow key is pressed, the next parameter will be displayed (see sec. 6.13, ‘Setup’ Key). Pressing an arrow key under a value will increment, select, or scroll through the valid values for the parameter. The Setup Configurations will be displayed in the following order:

SLO.n

Slow Down mode, where ‘n’ is the current setting.

drP.n

Anti-Drip mode, where ‘n’ is the current setting.

PAS.n

Dispense and pause mode, where ‘n’ is the current setting.

PS:nn

When pasue mode is enabled, displays the pause setting.

o t h r

Display secondary setup menu: Press any arrow key to select.

PF: n

Power Failure mode, where ‘n’ is the current setting.

AL: n

Alarm mode, where ‘n’ is the current setting.

TTL

Display TTL I/O external connector settings. Press any arrow key to select. If selected, the following will be displayed:

Tr:aa

Operational Trigger setting. 'aa' is current setting.

Dr:aa

Directional control setting. 'aa' is current setting.

rUrn.n

'Pump Motor Operating' TTL output pin configuration. 'n' is the current setting.

Lok.n

=> The "Lockout Disable Key" needs to be inserted to display this setting. Lockout setting changes from the keypad. 'n' is the current setting.

bP: n

Keypad beep enable, where 'n' is the current setting.

Rad:nn

RS-232 pump network address, where 'nn' is the network address.

nnnn

RS-232 pump network baud rate, where 'nnnn' indicates the baud rate.

Special Setup Menu

To access the special setup menu, press and hold the 'Setup' key while turning on power to the pump. The Setup Configurations will be displayed in the following order:

dIA

Set Tubing Inside Diameter

dISP

Set Dispense Mode

PLoC

Set Program Mode Lockout

done

Exit without making any selection

10.1 Slow Down Mode

SLO.n

Setting: '0' = Disabled, '1' = Enabled.

Slow-Down mode prevents over dispensing when pumping a large volume at a high speed. When enabled, the pump will incrementally slow down as the volume dispensed approaches the target dispense volume.

10.2 Anti-Drip Mode

drP.n

Setting: '0' = Disabled, '1' = Enabled.

When enabled, Anti-Drip mode will withdraw a small volume after the completion of a dispense to prevent dripping when the pump stops. The volume withdrawn is added to the next dispense.

10.3 Dispense, Pause, Repeat Mode

PAS.n

Setting: '0' = Disabled, '1' = Enabled.

When enabled, will create a more automated dispensing system, whereby the pump will continuously repeat the current dispense after a fixed time delay. The time delay will be displayed next:

PS.nn

PS.n.n

Where 'nn' is the pause time in seconds. Use the arrow keys to change the pause time. Valid pause times are 1 to 99 or 0.1 to 9.9 seconds. To set/clear the decimal point, scroll the right-most up arrow key past 9, or simultaneously press the 2 right-most up arrow keys.

10.4 Advanced Settings Menu

Other

The "Other" menu selection provides access to the more advanced settings menu.

10.5 Power Failure Mode

PF: n

Setting: '0' = Disabled, '1' = Enabled.

When enabled, if the Pumping Program was operating when power to the pump was disrupted, the Pumping Program will automatically start operating when power is reconnected to the pump. Pressing any key on the keypad while powering up the pump will stop the Pumping Program from starting.

In Dispense Mode, the pump will begin pumping according to the last selected Dispense.



CAUTION: If Dispense Mode is not set, then Pumping Program will start operating from the beginning of the Pumping Program (Phase 1), regardless of what part of the Pumping Program was operating when the power was disrupted.

10.6 Audible Alarm Enable

AL: n

Setting: '0' = Disabled, '1' = Enabled.

When alarms are enabled, the buzzer will be sounded as follows:

Condition	Buzzer Action
Pumping Program ended	Continuous beeping
Pumping Program paused for start trigger	Continuous beeping
Alarm condition	Steady alarm

Pressing any key will stop the alarm.

10.7 TTL I/O Operational Trigger Configuration

Tr:aa

Configures how the TTL I/O 'Operational Trigger' (pin 2) will control the Pumping Program's operation. (See sec. 13.1, *TTL I/O Operational Controls*). The 2 letter configuration Setting parameter to the right of the colon (:) is defined as follows:

Setting	Name	Function
Ft	Foot Switch	Falling edge starts or stops the Pumping Program
FH	Foot Switch Hold	Falling edge starts the Pumping Program Rising edge stops the Pumping Program
F2	Foot Switch Reversed	Rising edge starts or stops the Pumping Program
LE	Level Control	Falling edge stops the Pumping Program Rising edge starts the Pumping Program
St	Start Only	Falling edge starts the Pumping Program
t2	Start Only Reversed	Rising edge starts the Pumping Program
SP	Stop Only	Falling edge stops the Pumping Program
P2	Stop Only Reversed	Rising edge stops the Pumping Program

10.8 TTL I/O Directional Control Input Configuration

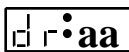

Configures how the TTL input 'Pumping Direction' (pin 3) will control the pumping direction. (See sec. 13.1, *TTL I/O Operational Controls*). The 2 letter configuration parameter to the right of the colon (:) is defined as follows:

Setting	Name	Function
rE	Reciprocating Pumps	Falling edge: Dispense; Rising edge: Withdraw
dU	Dual Pump	Falling edge: Withdraw; Rising edge: Dispense

The setting names are relevant to a 2 pump system, whereby the 'Directional Control Input' TTL pin is attached to the second pump's 'Pumping Direction Output' TTL pin.

10.9 Pump Motor Operating TTL Output Configuration



Configures the functionality of the 'Pump Motor Operating' TTL output pin (TTL pin 7).

Settings: 0: Sets the output to logic high only when the motor is operating (pumping).
Sets the output to logic low when the motor is not operating or when the Pumping Program is executing a pause timer or is stopped

1: Sets the output to logic high when the motor is operating (pumping) or when the Pumping Program is executing a pause timer.
Set the output to logic low when the Pumping Program is stopped

10.10 Keypad Lockout

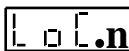

Setting: '0' = Disabled, '1' = Enabled.

*** The "Lockout Disable Key" needs to be inserted into the TTL I/O connector to display this setting***

When enabled, the "Lockout Disable Key" needs to be inserted into the TTL I/O connector to change any of the pump's settings. When the key is removed, the user can only start or stop the pump and review current settings. Settings can still be changed from RS-232. When the user attempts to change a setting,

the message  will be displayed.

Auto-Run Mode: When used in conjunction with the Program Select programming function as Phase 1, the pump will enter Auto-Run Mode. In this mode, on power up, the Pumping Program will immediately begin to execute and the user would be prompted to enter a dispensing program number.

The "Lockout Disable Key" connects the "Program Input", TTL connector pin 6, to Ground, pin 9. The "Lockout Disable Key" is available as an accessory item.

Lockout can also be disabled by performing a system reset, see sec. 6.16.2, "Reset the Pump."

10.11 Keypad Beep Enable

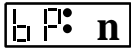

Setting: '0' = Disabled, '1' = Enabled.

When enabled, a single short beep will sound whenever a key is pressed on the keypad.

10.12 RS-232 Pump Network Configuration



The pump can be configured to communicate either with a computer or another pump. Communications with a computer (Address Mode) is the default setting and will be indicated by the [Ad:nn] display.

When in the default Address Mode, up to 100 pumps can be attached to a computer in a single pump network. The network address is defined by the 2 digits to the right of the colon (:). The valid range of addresses is from '00' to '99'. If only one pump is attached to the computer, set the network address to 0, [Ad:00] (factory default).

After the network address is displayed, the baud rate is displayed. Each pump in the pump network and the computer must have the same baud rate setting. Any arrow key can be used to scroll through the selection of baud rates. The supported baud rates are: 300, 1200, 2400, 9600, and 19200 (displayed as [1920]).

To change the communications mode:

With the network address displayed [Ad:nn], press the left-most arrow key to enter the communications mode menu. Pressing any arrow key will scroll through the menu selections:

[A d:nn]	Address Mode: Default communications with a computer mode.
[r E C P]	Reciprocating Pumps. Sends Start/Stop, Pumping rate and reverse pumping direction to an attached secondary pump.
[DUAL]	Reciprocating Pumps. Sends Start/Stop, Pumping rate and same pumping direction to an attached secondary pump.

Note: Communications with a computer requires the accessory cable: CBL-PC-PUMP-7.
 Communications with a secondary pump requires the accessory cable: CBL-DUAL

In Reciprocating or Dual Pumps Modes, the secondary pump must be left in its default communications setting of Address Mode, Address 0, and 19,200 baud rate. See the documentation with CBL-DUAL cable for more detailed information.

10.13 Set Tubing Inside Diameter Setting



For most applications, the default tubing inside diameter does not need to be changed since the pumping head is optimized for 3/16" inside diameter (ID) tubing.

When selected, the display will show the current diameter and the 'mm' units LED will blink. While the units LED is blinking, use the up arrow keys to enter the new diameter. For example, to enter 1/8" id tubing, use the up arrow keys to change the display to:

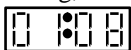

Press the 'LEARN' key, or wait for the time out to enter the new setting. The tubing diameter will now be set to the new setting. The new diameter will be used as the current calibration setting and override any previously entered calibration volumes.

10.14 Set Dispense Mode

DISP When selected, the dispense mode setting is displayed: **DIS.n**, where 'n' is the setting: '0' = Disabled, '1' = Enabled.

When enabled, the pump will be in Dispense Mode. Also, "Program Mode Lockout" will also be enabled or disabled.

10.15 Set Program Mode Lockout

PLoL When selected, the "Program Mode Lockout" setting is displayed: **P-L.n**, where 'n' is the setting: '0' = Disabled, '1' = Enabled.

When enabled, the user will not be able to enter Pumping Program edit mode unless the pump is already programmed with a multi-phase pumping program.

10.16 Exit special setup menu

done When selected, the special setup menu will be exited.

11. Pumping Program

A Pumping Program is simply a pre-defined sequence of actions, or functions, which guarantees consistent and precise operation of the pump, automatically, and with or without any user intervention. A Pumping Program can be as simple as continuous pumping at a fixed dispense rate. Or a Pumping Programs could consist of a pumping rate and direction of pumping for a specified volume, then switch to another pumping rate. Also a Program can interact with external devices through the TTL I/O connector, make decisions, or stop pumping for a period of time.

Programs are broken into individual operations called Phases. Each Phase consists of a function that can be a control function or pumping function. A pumping function, such as 'RATE', consists of a pumping rate, optional "Volume to be Dispensed", and the pumping direction.

Complex dispensing systems can be designed, involving multiple liquids, each dispensed from a different pump, plus other equipment and sensors. Pumping Programs can be designed for each pump which enables multiple pumps to synchronize with each other, and the other equipment and sensors, using a cable connected to the TTL I/O connectors of each pump.

When the Pumping Program is started, either from the keypad, TTL I/O connector, or from RS-232, the Pumping Program will begin with Phase 1 of the Program. After the completion of each Phase, the pump will immediately start the next consecutive Phase. This linear sequence of Phases can be altered by certain functions that direct the Pumping Program to continue operation with a different Phase number. Some functions can change the order of operation conditionally based on external events.

11.1 How to Enter Pumping Programs

Note: Dispense Mode needs to be off to enter a Pumping Program. Start by organizing your pumping requirements into specific actions and conditions that can then be programmed into Phases. For more advance programming methods, common groups of Phases can be grouped together and repeated multiple times using looping and jump functions.

The current values of the pumping rate, optional "Volume to be Dispensed", and pumping direction, all refer to the currently selected Phase. To display or change the currently selected Phase, enter "Program

Entry Mode” by pressing and holding the ‘Rate’/’Program Phase #’ key until the current Phase number is displayed. The display will show , where ‘01’ refers to Phase 1. The pump will now be in “Program Entry Mode”. If the current Phase is not 1, press and hold the ‘Rate’/’Program Phase #’ key until the display is as shown. The pump will now be in Phase 1.

When in “Program Entry Mode”, with the display showing the Program Phase number, pressing the ‘Volume’/’Program Function’ key will display the current “Program Function” for this Phase. If the current function is ‘RATE’, then a pumping dispense or withdrawal can be setup for this Phase.

To change the “Program Function” selected, use the arrow keys to scroll through the functions until the required function is displayed. If the function has an associated parameter, enter the parameter after the function has been stored.

Momentarily pressing the ‘Volume’/’Program Function’ key again will exit “Program Entry Mode” and display the “Volume to be Dispensed.” The pumping rate data, which includes the pumping rate, “Volume to be Dispensed” and pumping direction, can now be setup as previously described.

When finished setting up the pumping rate data for the current Phase, enter “Program Entry Mode” again to select the next Program Phase. Press and hold the ‘Rate’/’Program Phase #’ key until the Phase number is displayed. Then use the arrow keys to set the Phase number to the next Phase to be setup. Pressing the right-most arrow once will set the Phase to Phase 2. Now all pumping data will refer to Phase 2. The second Phase can now be setup as described above for Phase 1.

Continue selecting Phase numbers and entering the dispense or control setup for each Phase of the Pumping Program. The entire Pumping Program will be stored in non-volatile memory.

Use the ‘STOP’ function to stop the pump and end the Pumping Program. If the Pumping Program does not operate the pump continuously, the last Phase of the Pumping Program must be a ‘STOP’ function (unless the last Phase number is the maximum Phase number).

When the Pumping Program is started, with the ‘Start / Stop’ key, TTL I/O input, or RS-232 command, the Pumping Program will begin operating from Phase 1.

Very complex dispensing Programs can be created with the Program functions available. Section 11.3 contains a detailed description of all the functions.

11.1.1 Pumping Program Phase Number

To set the current Program Phase number, enter “Program Entry Mode” and display the current Program Phase number.

Using the right-most 2 arrow keys, change the selected Program Phase number. The displayed Program Phase number now becomes the currently selected Program Phase number. All function and pumping rate data will now refer to the currently selected Program Phase number.

If the maximum Program Phase number, 40, is exceeded while changing the Phase number, the displayed Phase number will automatically be set to the maximum Program Phase number.

11.2 Pumping Program Edit Functions

When developing or updating a large Pumping Program, occasionally one or more Program Phases needs to be added or removed from the Pumping Program. Having to re-enter the entire Program could certainly be a tedious task.

Two Program entry functions are available to simplify the Program development process. These are the ‘Insert’ and ‘Delete’ functions. They allow a Program Phase to be removed from any point in the Pumping Program or a Phase to be inserted at any point.

To access these functions, enter “Program Entry Mode” to display the Program Phase number [PH:nn]. Select the Program Phase number that is to be deleted or the Phase number where a new Phase is to be inserted in the Pumping Program.

For example, if a Phase is to be inserted between Phases 24 and 25, select Phase 25. The inserted Phase will be at Phase 25, and all the Phases starting with the old Phase 25 will be shifted one Phase higher.

Using either of the 2 left-most arrow keys, under 'PH' in the display, select the editing function. The arrow keys will scroll through the selection of editing functions:

<u>Editing Function</u>	<u>Description</u>
PH	Phase select
In	Insert Phase
dE	Delete Phase

When the required editing function is displayed, press the 'Rate'/'Program Phase #' key before the 2 second time out. After the time out, or with any other key press, the function will be canceled.

If 'Insert' or 'Delete' was selected, the Pumping Program will be edited. While the Program is being edited, the display will show [BUSY].

If 'Insert' was selected, all Phases from the selected Phase to the maximum Phase will be moved to the next higher Phase, with the original maximum Phase being deleted. The inserted Phase will default to a 'RATE' function, if it is the first Phase, or a 'STOP' function otherwise.

If 'Delete' was selected, the selected Phase will be removed, and all Phases higher then the selected Phase, up to the maximum Phase, will be moved to the next lower Phase.

All Phases that reference the Phase number of another Phase, such as a 'jump' function or an 'event' function, will be automatically updated. The referenced Phase numbers will be automatically adjusted to compensate for the section of the Pumping Program that was shifted during the operation of the edit function.

Ultimately, the easiest method to maintain and develop Pumping Programs is to download the Pumping Program to the pump from an attached computer. This would allow a single Pumping Program to be quickly programmed into multiple pumps. The computer would only need to be attached during the download since the Pumping Program is stored in the pump's non-volatile memory.

Also, a Pumping Program can be uploaded to an attached computer, which could then store it and produce a printout of the Pumping Program.

11.3 Program Function Descriptions

11.3.1 'rAtE': Rate Function

 Defines a pumping function with a fixed pumping rate. This function defines a pumping setup consisting of the pumping rate, optional "Volume to be Dispensed", and pumping direction. Use the 'Rate', 'Volume', and 'Pumping Direction' keys to set or review the pumping setup. For continuous pumping, set the "Volume to be Dispensed" to 0.0 (off). The "Volume to be Delivered" is disabled when the display reads [off].

11.3.2 'InCr': Increment Rate Function

 The Increment and Decrement functions will add ('INCR') or subtract ('DECR') the specified rate from the current pumping rate. The current pumping rate, when the function is executed, is the base pumping rate for the function. If no base pumping rate exists, such as when executing a pause function or when the Pumping Program is first started, a Program error will occur and the Program will stop.

The pumping rate units will be the same as the base pumping rate, and therefore cannot be set, nor are they displayed, with the increment or decrement value. Instead of a volume target, a time target is specified in "minutes:seconds". If time is set to 0, the phase will execute continuously. The pumping direction can also be specified.

When used within a Program loop, the pumping rate can be incremented or decremented in small step intervals of fixed time.

11.3.3 'DECr': Decrement Rate Function

 The decrement function subtracts the specified rate from the current pumping rate. For a full description, see section 11.3.2, 'InCr': Increment Rate Function

11.3.4 'StoP': Stop Pumping Operation and End the Program

 Stops the pumping operation and stops the Pumping Program. The Pumping Program will begin at Phase 1 when started again. An implicit 'Stop' function is executed when the Program exceeds the maximum Phase number during operation.

If alarms are enabled, the buzzer will beep continuously when the Pumping Program stops.

11.3.5 'JP:nn': Jump to Phase

 The 'Jump' function alters the consecutive operation of Program Phases. When executed, the Pumping Program will continue operation with Phase 'nn'.

11.3.6 'Pr:In': Program Selection Input

The Pumping Program can be broken into sub-programs which can be selected by the user.

Auto-Run Production Mode: When Phase 1 is set to Program Selection Input, and Lockout Mode is selected, the pump will enter Auto-Run Mode. When the pump is powered on, it will immediately begin executing the Pumping Program. The user will immediately be prompted to enter a sub-program number. This permits a set of production dispenses to be programmed into the pump. The user then would only be able to select from one of these production dispenses and not make any changes.

Foot Switch Trigger Feature: If the Pumping Program was Paused, and the Paused Phase was a continuous pumping Rate function, then starting the pump with a foot switch will cancel the Pause and restart the Pumping Program Phase 1 causing the current program selection to be re-executed.

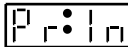
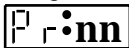
When the Program Selection Input function  is executed, the Pumping Program pauses and displays: , where 'nn' is the Program Selection.

Using the right 2 arrow keys, under 'nn', the user enters the Label of the required Pumping Program. The Pumping Program Label is defined by any number from 1 to 99. When the 'Start' key is pressed, the Pumping Program continues execution at the Program Phase with the selected Pumping Program Selection Label. Also, the accumulated dispense and withdrawal dispensed volumes are set to zero.

The pump searches for the selected Pumping Program Selection Label starting with the current Phase and continuing to the end of the Pumping Program memory, then from Phase 1 until the current Phase is reached again. If the selected label is not found, the 'out of range' error message  is displayed. Pressing any key returns the display to the Program Selection Input display.

If more than one Phase is defined with the same label, then execution continues with the first matching label encountered. The last selected program label is stored in non-volatile memory and becomes the default label the next time the current Program Phase is executed. More than one Program Selection Input function can be defined and placed at any Program Phase needed. To cancel the Program Select Input and stop the Pumping Program, turn the power to the pump off and on.

If alarms are enabled, the buzzer will beep continuously while waiting for the start trigger.

11.3.7 'Pr:nn': Program Selection Label

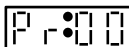
The Sub-Program Start Label function  defines the start of a Pumping Program sub-program that can be selected by the user during Pump Program execution.

After selecting the function, change '00', if needed, to a unique Program Label, from 0 to 99. See sec: 11.3.6, 'Pr:In': Program Selection Input for a full description. Place a Sub-Program Start Label, with a unique number for each Sub-Program, from 0 to 99, at the starting Phase of each sub-program section.

When the Pumping Program encounters a Sub-Program Start Label in normal execution, it will interpret the label as a Stop function, stopping the pump and ending the Pumping Program.

11.3.8 'LP:ST': Define Starting Phase of Loop



Defines the start of a Program loop. For a full description of Program looping, see sec. 11.3.10, 'LP:nn': .

11.3.9 'LP:EN': Define Continuous Loop End

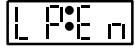

Loops to the most recently executed, unpaired, 'loop start' Phase, or Phase 1 if none. This function allows a section of the Program to be repeated continuously. For a full description of Program looping, see sec. 11.3.10, 'LP:nn': .

11.3.10 'LP:nn': Define Loop End and Loop Repetitions

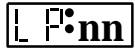

Repeats execution of the defined loop 'nn' times.

Loop starts and loop ends are uniquely **paired** during looping. When an unpaired 'loop end' function is executed, it is paired with the most recent unpaired 'loop start' function executed ('LP:ST'). If no unpaired 'loop start' function exists, Phase 1 is used as an implied unpaired 'loop start'. This pairing defines the loop and the range of Phase numbers between the paired loop functions defines the **scope** of the loop.

When a 'loop end' function is executed, Program operation continues with the 'loop start' function paired with the loop end function. There are 2 'loop end' functions: Loop continuous ('LP:EN') and Loop for a preset number of iterations ('LP:nn'), indicated by 'nn'. Each time a paired 'loop end' function is executed, an iteration of the loop is complete. With the 'LP:nn' function, after 'nn' number of loop iterations, the defined loop is complete and Program execution continues with the next Program Phase after the 'loop end' function. The loop is then no longer defined or paired.

While executing Phases within the scope of a defined loop, another 'loop start' and 'loop end' can be paired and become a defined loop within the scope of the first loop, which is referred to as the outer loop. The new loop being referred to as the inner loop. The pairing of a loop within a paired loop is referred to as nesting of loops, with each loop being one nested layer for the duration of the loops pairing. Loops can be nested for a total of 3 layers deep. Loops can only be nested within the scope of an outer loop.

11.3.11 'PS:nn': Pause Pumping

If 'nn' is non-zero, the Pumping Program will pause pumping (stops pumping) for 'nn' seconds. When executed, the display will show , with 'nn' decrementing to indicate the number of seconds until the next Program Phase is executed. After the pause interval, the next Program Phase will be executed.

To set a pause time in tenths of seconds, select the decimal point between the digits. Simultaneously press the 2 up arrow keys below the digits to set or clear the decimal point. Alternatively, press and hold the right-most up arrow key until the right-most digit scrolls to 9. After 9, the decimal point between the 2 digits will toggle on and off . Release the key when the decimal point is displayed, or cleared, as required. Now enter the required pause time from 0.1 to 9.9 seconds.

For pauses longer than the '99' second maximum pause for this function, put the pause function within a Program loop. A Program section with the following functions in consecutive Phases:

[LP:ST] [LP:ST] [PS:60] [LP:60] [LP:24],

will pause the Pumping Program for 24 hours.

If 'nn' is '00' then the Pumping Program pauses and waits for a start trigger to resume the Program. The display will show  when waiting for a start trigger.

After the start trigger, the Program will resume with the next Phase. The start trigger can be from any source, the 'Start'/'Stop' key, the TTL I/O Operational Trigger, or from RS-232. Any other key input will stop and reset the Pumping Program.

If alarms are enabled, the buzzer will beep continuously while waiting for the start trigger.

11.3.12 'IF:nn': Jump to Phase If External Trigger

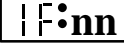
 The 'IF' function conditionally alters the Pumping Program's execution based on an external signal.

When executed, if the TTL I/O Program Input pin (pin 6) is low level, then the Pumping Program continues operation with Phase number 'nn'. Otherwise, the Pumping Program continues operation with the next Phase.

11.3.13 'Et:nn': Setup Event Trigger Jump Phase

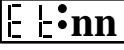
 The 'Event' function sets a background event trap that is triggered by an external signal.

This one time background trap, or interrupt, stays set during the Pumping Program's entire execution until it is triggered, redefined, or reset. This function has no other effect on the operation of the pump until it is triggered.

The event is triggered with either:

- 1) A falling edge (high to low TTL transition) occurs on the TTL 'Event Trigger' input (pin 4).
- 2) A low level on the 'Event Trigger' input pin at the time the function is executed.
- 3) The RS-232 'RUN E' command.

When triggered, the current operation of the pump and the Pumping Program is interrupted, and the Pumping Program immediately continues operation (jumps to) with Phase number 'nn'.

After being triggered, the event trigger is reset. If an event trigger function is executed (either 'Et' or 'ES' function) while another event trap is still set, the new event trigger will replace the previous event trap. Only one event can be defined at any time.

11.3.14 'ES:nn': Setup Event Square Wave Trigger Jump Phase

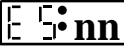
 The 'Event Square Wave' function operates the same as the 'ET' 'Event' function, with the exception of the triggering conditions.

The event is triggered with either:

- 1) The rising or falling edge of the TTL 'Event Trigger' input (pin 4).
- 2) The RS-232 'RUN E' command.

Therefore, a square wave function on the input pin can be used to toggle the pump between 2 sections of a Pumping Program. An example of this would be a Pumping Program that switched between a slow and fast pumping rate, controlled by a square wave input.

11.3.15 'Et:rS': Event Reset

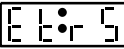
 'Event Reset' cancels a previously set event trap by either the 'ES' or 'ET' function.

11.3.16 'OUt.n': Set TTL Output Pin

 Set 'Program Output' TTL I/O output (pin 5) to level 'n'. If 'n' = 0, the output pin will be set low. If 'n' = 1, the output pin will be set high.

11.3.17 'bEEP': Beep



Sounds a short beep.

11.4 Pumping Program Examples

11.4.1 Example 1: 2 Step Rate

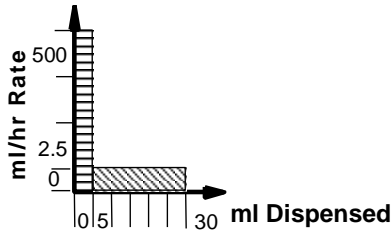

Dispense 5.0 mL at 500 mL/min, and then dispense 25.0 mL at 2.5 mL/min. Then stop the pump.

Phase	Function	Rate	Volume	Direction
1	RATE	500 mL/min	5.0 mL	Dispense

Phase	Function	Rate	Volume	Direction
2	RATE	2.5 mL/min	25.0 mL	Dispense

Phase	Function
3	STOP

11.4.2 Example 2: Repeated Dispenses with Suck Back

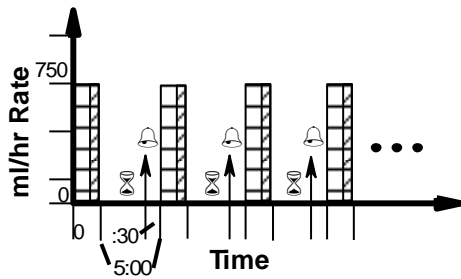

Dispense 2.0 mL with a 5 minute pause between dispenses. In addition, after each dispense, a volume of 0.25 mL is sucked back to prevent dripping. Also, 30 seconds before the end of the pause interval, a beep is sounded to alert the operator to prepare for the next dispense.

Starting with the second dispense, 0.25 is added to the volume dispensed to compensate for the sucked back volume of the previous dispense. By changing the last Phase to a [LP:nn] function, the total number of dispenses can be set.

When entering a function with associated data, such as with the 'Pause' in Phase 5, or the 'Loop' in Phase 6, the function is entered in 2 steps. First select the function and store it. Then enter the associated data.

Phase	Function	Rate	Volume	Direction
1	RATE	750 mL/min	2.0 mL	Dispense

Phase	Function	Rate	Volume	Direction
2	RATE	750 mL/min	0.25 mL	Withdraw

Phase	Function
3	LP:ST

Phase	Function
4	LP:ST

Phase	Function
5	PS:90

Phase	Function
6	LP:03

Phase	Function
7	BEEP

Phase	Function
8	PS:30

Phase	Function	Rate	Volume	Direction
9	RATE	750 mL/min	2.25 mL	Dispense

Phase	Function	Rate	Volume	Direction
10	RATE	750 mL/min	0.25 mL	Withdraw

Phase	Function
11	LP:EN

11.4.3 Example 3: Ramping the Flow Rate

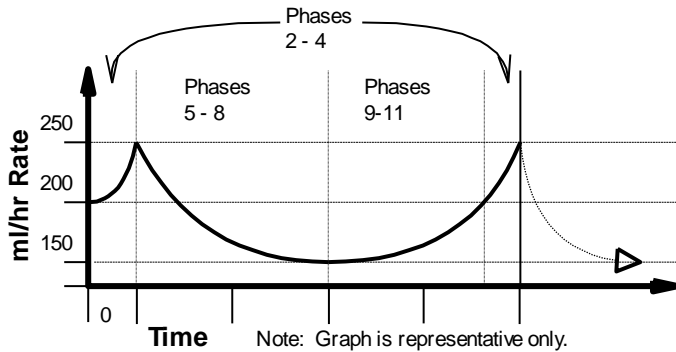

Continuously ramp up and down the pumping rate. Starting at 200 mL/min, the pumping rate will increment to 250 mL/min in 1.0 mL/min steps after every 0.1 mL has been dispensed. Then the pumping rate will decrement to 150 mL/min in 1.0 mL/min steps after every 0.1 mL has been dispensed. Finally, the pumping rate is incremented back to 200 mL/min in 1.0 mL/min steps after every 0.1 mL has been dispensed, then the process is repeated.

Phase	Function	Rate	Volume	Direction
1	RATE	200 mL/min	0.1 mL	Dispense

Phase	Function
2	LP:ST

Phase	Function	Rate	Volume	Direction
3	INCR	1.0	0.1 mL	Dispense

Phase	Function
4	LP:50

Phase	Function
5	LP:ST

Phase	Function	Rate	Volume	Direction
6	DECR	1.0	0.1 mL	Dispense

Phase	Function
7	LP:99

Phase	Function	Rate	Volume	Direction
8	DECR	1.0	0.1 mL	Dispense

Phase	Function
9	LP:ST

Phase	Function	Rate	Volume	Direction
10	INCR	1.0	0.1 mL	Dispense

Phase	Function
11	LP:50

Phase	Function
12	JP:02

11.4.4 Example 4: Complex Dispenses with External Synchronization

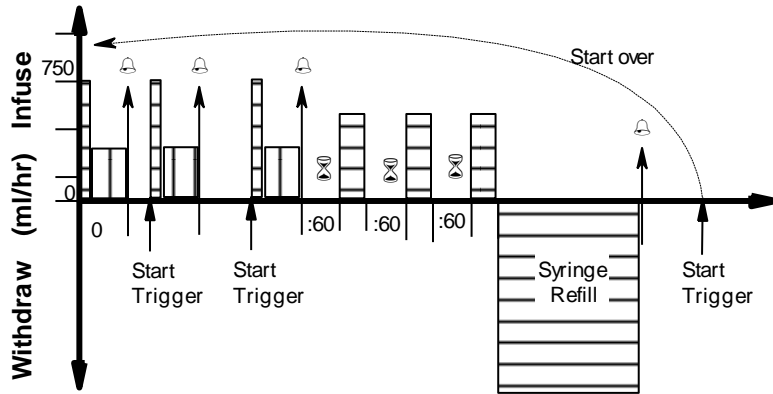

A more complex dispensing example, this Program contains different pumping requirements, including dispenses with multiple pumping rates. The first set of 3 dispenses drops down to a lower pumping rate during the dispense. When each dispense is completed, the buzzer beeps to alert the operator, then the pump waits for a start trigger before starting the next dispense.

The next set of 3 dispenses have a fixed time interval of 60 seconds between dispenses. After the last set of dispenses, the syringe is refilled by the amount dispensed, 17.25 mL. Then the buzzer beeps, to alert the operator to the start of the first set of dispenses. The process is then repeated.

Phase	Function	Rate	Volume	Direction
1	RATE	750.0 mL/min	0.5 mL	Dispense

Phase	Function	Rate	Volume	Direction
2	RATE	300.0 mL/min	1.5 mL	Dispense

Phase	Function
3	BEEP

Phase	Function
4	PS:00

Phase	Function
5	LP:02

Phase	Function	Rate	Volume	Direction
6	RATE	750.0 mL/min	0.5 mL	Dispense

Phase	Function	Rate	Volume	Direction
7	RATE	300.0 mL/min	1.5 mL	Dispense

Phase	Function
8	BEEP

Phase	Function
9	LP:ST

Phase	Function
10	PS:60

Phase	Function	Rate	Volume	Direction
11	RATE	500.0 mL/min	3.75 mL	Dispense

Phase	Function
12	LP:03

Phase	Function	Rate	Volume	Direction
13	RATE	900.0 mL/min	17.25 mL	Withdraw

Phase	Function
14	BEEP

Phase	Function
15	PS:00

Phase	Function
16	LP:EN

11.4.5 Example 5: Control from a High-Low Pressure Sensor

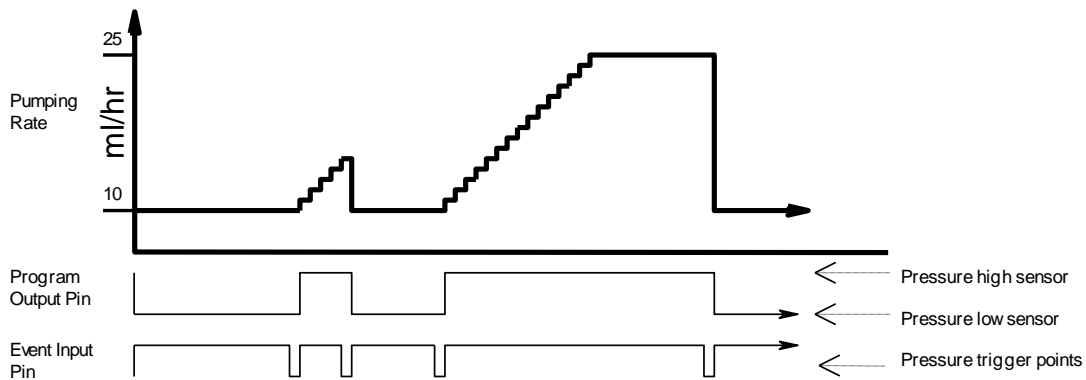

This example demonstrates a Pumping Program whose control depends on an external sensor. Assuming a pressure sensor that is configured to detect a high pressure point and a low pressure point, the Pumping Program individually selects whether it will react to the high or low pressure point.

The “Program Output” pin on the TTL I/O connector (pin 5) is used to select the high or low pressure point. When low, the low pressure point is selected (PH:01), and when high, the high pressure point is selected (PH:05). The Program begins by dispensing continuously at 10.0 mL/min (PH:02), while a background trap is set for the low pressure point (PH:03). To create a delay when the pressure sensor is switched from high pressure to low pressure when the “Program Output” pin is set, a small volume is pumped (PH:02, 06) before the background traps are set.

When the low pressure trap is triggered, the pump sets the high pressure trap (PH:07) and begins to increment the flow rate. The flow rate is incremented in 1.0 mL/min steps with every 0.25 mL dispensed (PH:08-10). If the high pressure trap hasn’t as yet been triggered, the flow rate will max out at 25.0 mL/min while waiting for the high pressure trap (PH:11). When the high pressure point is reached, the pump immediately will drop down to 10.0 mL/min (PH:02), and once again wait for the low pressure point.

Phase	Function
1	OUT.0

Phase	Function	Rate	Volume	Direction
2	RATE	10.0 mL/min	0.005	Dispense

Phase	Function
3	EV:05

Phase	Function	Rate	Volume	Direction
4	RATE	10.0 mL/min	0.0 mL (off)	Dispense

Phase	Function
5	OUT.1

Phase	Function	Rate	Volume	Direction
6	RATE	10.0 mL/min	0.005	Dispense

Phase	Function
7	EV:01

Phase	Function
8	LP:ST

Phase	Function	Rate	Volume	Direction
9	INCR	1.0	0.25 mL	Dispense

Phase	Function
10	LP:14

Phase	Function	Rate	Volume	Direction
11	RATE	25.0 mL/min	0.0 mL (off)	Dispense

11.4.6 Example 6: Automated Dispensing with Synchronization

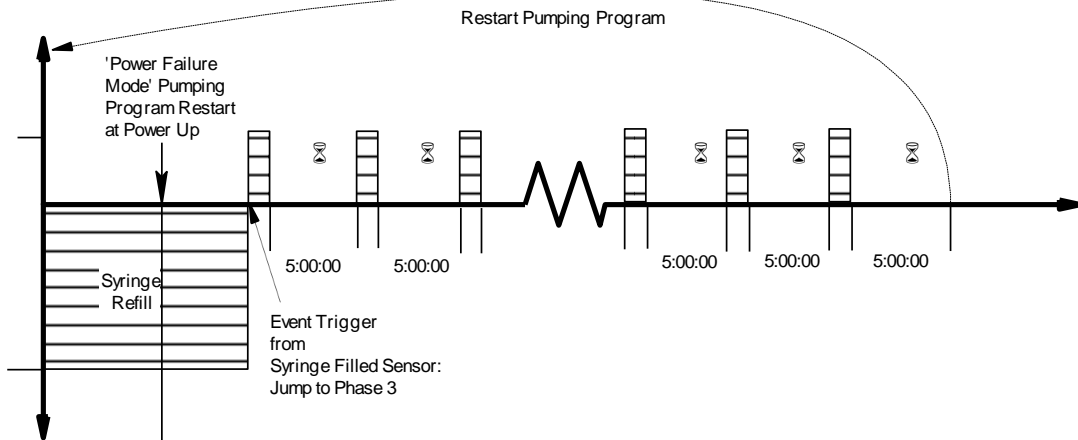

The following is an automated dispensing Program for a NE-9000 peristaltic pump equipped with a ‘Syringe Filled Sensor’ attached to the TTL I/O connector, and a valve system to refill the syringe from a reservoir. It is also assumed that the ‘Power Failure’ mode is enabled.

After a power fail restart, the pusher block is in an unknown position, making it impossible for an automated dispensing system to regain synchronization. With the Syringe Filled Sensor, the following Pumping Program will automatically synchronize the dispensing system, and then continue with the normal dispense.

The first 2 Phases set an event trap for the Syringe Filled Sensor and refills the syringe until the sensor is triggered. When the sensor triggers the event, the pump’s pusher block will be synchronized with the Pumping Program. It is assumed that the sensor is positioned to refill the syringe with 60 mL. A withdraw volume of 61 mL is set as a safety feature.

After the syringe is refilled, one 5 mL dispense is made every 5 hours. After 12 dispenses, the syringe is refilled using the sensor again.

Phase	Function
1	EV:03

Phase	Function	Rate	Volume	Direction
2	RATE	900.0 mL/min	61 mL	Withdraw

Phase	Function
3	LP:ST

Phase	Function	Rate	Volume	Direction
4	RATE	200.0 mL/min	5.0 mL	Dispense

Phase	Function
5	LP:ST

Phase	Function
6	LP:ST

Phase	Function
7	PS:60

Phase	Function
8	LP:60

Phase	Function
9	LP:05

Phase	Function
10	LP:12

Phase	Function
11	JP:01

11.4.7 Example 7: Sub-Programs

This example shows some of the flexibilities provided by the Program Selection functions. The Pumping Program starts by refilling the syringe with 50 mL at a fast pumping rate (Phase 1), then the Pumping Program pauses for user sub-program selection (Phase 3). Then performs 5 dispenses of 10 mL at the selected rates, then refills the syringe again and pauses for the next user sub-program selection.

The user is given the option of choosing one of three defined sub-programs.

- 1: Dispense 10 mL at 100 mL/min (Phase 4)
- 2: Dispense 10 mL at 500 mL/min (Phase 7)
- 3: Dispense 10 mL at 750 mL/min (Phase 10)

After selecting the sub-program and pressing 'Start', the Pumping program continues execution at the selected sub-program. After the 10 mL dispense, each sub-program jumps or continues with the loop counter function (Phase 12). The first 4 loops continue Program Execution with the next user sub-program selection. After the 5th loop, the program continues with Phase 13, which jumps back to the syringe refill function and starts the whole program over.

Phase	Function	Rate	Volume	Direction
1	RATE	1500.0 mL/min	50 mL	Withdraw

Phase	Function
2	LP:ST

Phase	Function
3	PR:IN

Phase	Function
4	PR:01

Phase	Function	Rate	Volume	Direction
5	RATE	100.0 mL/min	10 mL	Dispense

Phase	Function
6	JP:12

Phase	Function
7	PR:02

Phase	Function	Rate	Volume	Direction
8	RATE	500.0 mL/min	10 mL	Dispense

Phase	Function
9	JP:12

Phase	Function
10	PR:03

Phase	Function	Rate	Volume	Direction
11	RATE	750.0 mL/min	10 mL	Dispense

Phase	Function
12	LP:05

Phase	Function
13	JP:01

11.4.8 Example 8: Dispensing with Complex Synchronization

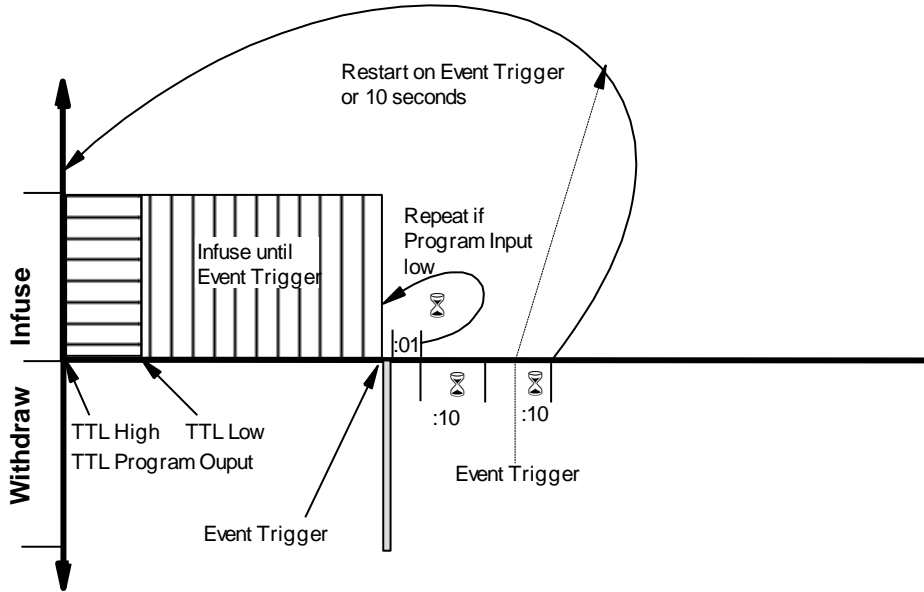

This example demonstrates a complex interaction with external equipment, such as synchronizing with another peristaltic or syringe pump. The Program includes a variety of interactions with external equipment, which demonstrates the various control possibilities of the NE-9000.

The Pumping Program begins by canceling any previous event traps (PH:01) and raising the ‘Program Output’ TTL line (PH:02). After 5.0 mL has been dispensed at 800 mL/min (PH:03), the ‘Program Output’ TTL line is lowered (PH:04), sending a synchronization signal to another device.

The pump then continues to pump at 800 mL/min (PH:06) until a synchronization signal is received at the ‘Event Trigger’ TTL input, causing the Program to jump to Phase 7 (PH:05).

The pump then withdraws 0.25 mL (PH:07), pauses for 1 second (PH:08), then repeats this process if the Program Input TTL line is low (PH:09), otherwise it continues with the next Phase.

Next, the pump pauses for 10 seconds (PH:10). Then it pauses again for the lesser of another 10 seconds (PH:12) or until an Event Trigger occurs (PH:11). The Program then restarts (PH:13).

Phase	Function
1	ET:RS

Phase	Function
2	OUT.1

Phase	Function	Rate	Volume	Direction
3	RATE	800.0 mL/min	5.0 mL	Dispense

Phase	Function
4	OUT.0

Phase	Function
5	ET:07

Phase	Function	Rate	Volume	Direction
6	RATE	800.0 mL/min	0.0 mL (OFF)	Dispense

Phase	Function	Rate	Volume	Direction
7	RATE	900.0 mL/min	0.25 mL	Withdraw

Phase	Function
8	PS:01

Phase	Function
9	IF:07

Phase	Function
10	PS:10

Phase	Function
11	ET:01

Phase	Function
12	PS:10

Phase	Function
13	JP:01

12. RS-232 Communications

The NE-9000 Peristaltic Pump can communicate with any computer or device with an RS-232 communications port. The following assumes that the default Address Communications Mode is set.



12.1 Connection and Networking

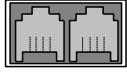

On the rear of the pump are 2 square RJ-11 (“phone jack” style) sockets. Connect the RS-232 cable into the socket labeled “To Computer”. Connect the other end to the serial port on the computer, or other control device. Turn power off to the pump and the computer before connecting cables.

If the pump is part of a pump network, connect a pump network cable between the socket labeled “To Network”, on the first pump, and the socket labeled “To Computer” on the next pump in the network. Repeat for each pump in the network, connecting the “To Network” socket of one pump to the “To Computer” socket on the next pump in the network. Up to 100 pumps can be networked together with a computer. See section 13, Logic Interface: TTL Input and Output, for a diagram of the rear of the pump. When communicating with a pump in a multi-pump network, each preceding pump in the network must be powered on.

Each pump in the network needs a unique network address to identify the pump to the computer. Network addresses are from 00 to 99. If the network consists of only 1 pump, set the pump’s address to 0. Also, each pump needs to be set to the same baud rate as the computer. Use the ‘Setup’ function on the keypad to set the network address and the baud rate. See section 6.13, ‘Setup’. The ‘*ADR’ command can also be used to set the network address.

The supported baud rates are 300, 1200, 2400, 9600, and 19200. The trade-off on baud rates is communications speed versus noise immunity. For most environments, 19200 would be acceptable. But in environments that are electrically noisy and/or over long cables, the communications signal may degrade or be disrupted, causing communications errors. In these situations, a lower baud rate may improve the reliability of the communications.

12.2 RS-232 Protocol:

When the pump is used in a multi-pump network configuration, precede each command with a pump address. Pumps will ignore all commands that do not have their defined network address. If the network address is not specified in the command, the address will default to 0.

After a command is sent to the pump, the pump will not accept any further communications until the current command has been processed. Completion of the command processing is indicated when the first byte of the response packet is transmitted. While the user is changing data or configurations from the keypad, command processing is delayed.

A triangle appears in the upper left corner of the LCD display after the pump has received valid communications. This triangle remains in the display until the pump is powered off or until ‘Setup Configuration’ is entered.

Communications to and from the pump use the following data frame:

Supported RS-232 Data Frames

Baud rates:	19200, 9600, 2400, 1200, or 300
Frame:	10 bit data frame (8N1):
Start bit:	1
Data bits:	8
Stop bits:	1
Parity:	None

Every command received by a pump in the network is acknowledged by the pump with a response packet that includes a status character indicating the current operational state of the pump.

Two packet protocols are supported, Basic and Safe. The enabled communications protocol is stored in non-volatile memory, and therefore will be in effect at power up. Safe Mode provides a safer communications protocol than Basic Mode. Safe Mode detects corrupted data and loss of communication, as well as automatically transmitting status packets when an alarm occurs.

Considering that the 19200 baud rate communicates at 52 μ s per bit, a small glitch on the RS-232 cable, flipping a single bit, can convert a transmitted dispense rate of 100 mL/min into 900 mL/min, the need for the Safe Mode in a production environment is evident. However, Basic Mode is excellent for simplifying early development of a control program.

While in the Basic Mode, the pump will accept either communications protocol, Basic or Safe, although the response packet will be in the current communications mode. This allows a computer's communication's driver to be designed with just one mode. A Safe Mode communications driver can send a 'SAF' command to the pump in the Safe Mode protocol while the pump is in Basic Mode. The response to the 'SAF' command, enabling Safe Mode, will then be in the Safe Mode protocol.

12.2.1 RS-232 General Syntax Legend

The following syntax expansion legend is common to all syntax expansions:

Except where indicated, all command and response characters are ASCII data.

<float> => <f> [<float>]	Floating point number. Maximum of 4 digits plus 1 decimal point. Maximum of 3 digits to the right of the decimal point.
<volume units> => OZ ML	Oz (Ounces) mL (milliliters)
<TTL level> => 1 0	TTL high level TTL low level
<on-off> => 1 0	On, enabled Off, disabled
<phase data> => <n> [<n>]	Program Phase number. Valid values: 1 to 40
<count data> => <n> [<n>]	Valid values: 1 to 99
<number data> => <n> [<n>]	Valid values: 0 to 99
<text> => "any printable character" [<text>]	
<f> => { <n> . }	Floating point digits
<n> => { 0 1 2 3 4 5 6 7 8 9 }	Digits
<byte> => "one byte of any data"	
()	One byte of data expressed as (0xhh), where 'hh' is the data in hexadecimal.
=>	Is defined by. Syntax expands to next level of expansion.
<>	Non-terminal syntax expansion
[]	Optional syntax
{ }	Required syntax
	Or. Choose one of the syntax options.
λ	None. Syntax expands to nothing (lambda production).
" "	Description of syntax expansion

12.2.2 RS-232 Protocol: Basic Mode

Command syntax (to pump):

<basic command protocol> => <command data> <CR>

Response syntax (from pump):

<basic response protocol> => <STX> <response data> <ETX>

In the “Basic” communications mode, a master-slave protocol is used, whereby the pump will only transmit in response to a received command.

When the pump receives the <basic command protocol>, <command data> will automatically be stripped of all space and control characters, and all text will be converted to upper case. This simplifies communications with the pump when commands are being manually typed in from a generic terminal emulator.

To return the pump to Basic mode when in the Safe mode, send the following packet to the pump:

(0x2) (0x8) SAF0 (0x55) (0x43) (0x3)

12.2.3 RS-232 Protocol: Safe Mode

Command syntax (to pump):

<safe command protocol> => <STX> <length> <command data> <CRC 16> <ETX>

Response syntax (from pump):

<safe response protocol> => <STX> <length> <response data> <CRC 16> <ETX>

Safe mode uses a more structured protocol including detection of corrupted communications, communications time outs, and auto-alarm responses. Safe mode is enabled using the ‘SAF’ command whose parameter setting is stored in the non-volatile memory.

Safe mode uses a modified master-slave protocol, whereby the pump transmits in response to a received command. But, the pump also automatically transmits a status packet when an alarm condition occurs.

Corrupted communications is detected using the 16 bit CCITT CRC algorithm computed over <transmitted data>. Packets transmitted and received include the CRC within the packets.

The parameter sent with the “SAF” command is the communications time out. This time out, in seconds, is the time between the reception by the pump of consecutive valid communications packets. Each time a valid communications packet is received, the time out is reset. If the time out elapses, a pump alarm will

occur, stopping the pump and the Pumping Program. The pump will display , and the buzzer will sound, if alarms are enabled, alerting the user. The communications time out timer will not restart until the next reception of a valid packet.

In addition, there is a 0.5 second packet inter-byte time out. While receiving a communications packet, and before its complete reception, if a delay of 0.5 seconds occurs between bytes, the incomplete packet will be discarded.

With the Auto-Alarm feature, whenever a pump alarm occurs, such as a pump stall, a response packet with the alarm status information will automatically be transmitted.

Until the Safe Mode is disabled, each time power is applied to the pump, the pump defaults to the Safe mode of communications, but the communications time out timer will not be enabled until the first reception of a valid packet.

Although the communications time out timer is not enabled, the Auto-Alarm feature will be enabled. Therefore, the pump will be in an Auto-Alarm only communications mode.

When power is applied to the pump, or if the system should reset, a system reset alarm occurs. The Auto-Alarm feature, therefore, alerts the host computer that a pump reset has occurred.

Also, when the user changes the baud rate, the communications time out timer is disabled until the next valid communications packet.

12.2.4 RS-232 Protocol: Basic and Safe Mode Common Syntax

<transmitted data> => { <command data> <response data> }	
<command data> => [<address> *] [<command>]	To pump
<response data> => <address> <status> [<data>]	From pump
<status> => { <prompt> <alarm> }	Operational state of pump
<prompt> =>	
I	Dispensing
W	Withdrawing
S	Pumping Program Stopped
P	Pumping Program Paused
T	Timed Pause Phase
U	Operational trigger wait (user wait)
X	Purging
<alarm> => A ? <alarm type>	Alarm
<alarm type> =>	
R	Pump was reset (power was interrupted)
S	Pump motor stalled
T	Safe mode communications time out
E	Pumping Program error
O	Pumping Program Phase is out of range
<address> => <n> [<n>]	Pump network address, 0 to 99
*	System command
<data> => <text>	Response to command
<CR> => (0x0D)	Carriage return
<STX> => (0x02)	Start of packet transmission indicator
<ETX> => (0x03)	End of packet transmission indicator
<CRC 16> => <byte> <byte>	16 bit CCITT CRC of <transmitted data> (high byte, low byte)
<length> => <byte>	Number of bytes remaining in packet, including this byte

12.2.5 Network Command Burst

The Network Command Burst feature is only applicable when communicating to a network of pumps.

This special feature allows commands to be sent to a network of pumps simultaneously. For example, changing the pumping rates simultaneously on a network of pumps.

Note: Since this special feature violates the general communications protocol of one command-one response, all of the pumps will be responding simultaneously, and therefore the communications response to a Network Command Burst will be gibberish and should be ignored.

Command Format

Command Burst => <n> <command> *

Network Command Burst => < Command Burst > [Network Command Burst]

Where <n> indicates the address of the pump that is to execute <command>. Maximum address is 9.
n => {0 ... 9}

Example: Simultaneously change the pumping rates of 3 pumps on a pump network as follows:

Pump 0: 100 mL/min
Pump 1: 250 mL/min
Pump 2: 375 mL/min

Assumes that the current pumping rate units of all 3 pumps are currently mL/min.

Send the following command, followed by a carriage return <CR>, (spaces are optional):

```
0 rat 100 * 1 rat 250 * 2 rat 375 *
```

12.3 Command Errors and Alarms

If a command received by the pump is not recognized or the data is invalid, an error message will be in the <data> field of the response packet following the <prompt> field. The following are the error responses:

<command error> => ? <error>

<error> =>

λ	Command is not recognized ('?' only)
NA	Command is not currently applicable
OOR	Command data is out of range
COM	Invalid communications packet received
IGN	Command ignored due to a simultaneous new Phase start

When an alarm occurs, the alarm must be acknowledged before any data is changed or the pump is started. Alarms are acknowledged by the user clearing the alarm message on the keypad, or the alarm status being sent in response to any valid RS-232 command. An alarm message sent automatically in the Safe Mode will not clear the alarm condition. This is to verify that the alarm message was sent to a receptive host, such as after a power failure when both the computer and the pump were reset. In this case, the pump will most likely send its reset alarm message before the computer has finished booting.

12.4 RS-232 Command Set

All data changed from RS-232 is stored in the non-volatile memory, except for changes to the pumping rate while pumping. All "Program Phase Data" refers to the currently selected Program Phase. Use the Phase select command ('PHN') to query or select the current Phase. A Phase consists of the pumping rate, 'Volume to be Dispensed', and the pumping direction.

A packet without a command is interpreted as a status query. The addressed pump responds with a status only response packet.

Except where noted, a command without any parameters is a query command. The response packet data will include the requested data. In general, the query response data will be in the same format as the parameters for setting the command. For example, the query volume command 'VOL' will respond with '<float>' as the response '<data>'.

Otherwise, the command is a set command. If the data was set, a status only response packet will be sent. If the data was not set, the response packet will include an error (<command error>) message indicating why the data was not set.

All commands are upper case.

<command> =>

TUBING INSIDE DIAMETER

DIA [nn / nn]

Set/query peristaltic tube inside diameter. Set is only valid when the Pumping Program is not operating. Setting the tube inside diameter resets any entered calibration volumes. The new diameter is used for calibration.

CALIBRATION

CAL <float>

Calibrates the tubing diameter using <float> as the measured dispense volume, and the volume dispensed or withdrawn, according to the current pumping direction. The calibration value cannot be queried. The pump must be stopped to calibrate.

12.4.1 Program Function Commands

The following commands are relevant to the currently select Program Phase. Note: During a Pumping Program's operation, the currently selected Phase can change automatically.

PHASE NUMBER

PHN [<phase data>]

Set/query currently selected Program Phase:

Set:

Currently selected Phase is set to <phase data>. Previous Phase is stored in non-volatile memory and the requested Phase is recalled from the non-volatile memory. Set is only valid if the Pumping Program is not operating.

Query response:

<phase data>

Currently selected Phase.

PUMPING PROGRAM FUNCTION

FUN [<phase function>]

Set/query the Pumping Program Phase's function.

This command is relevant to the currently selected Phase. Set is only valid if the Pumping Program is not operating

For a more detailed description of Program commands, see sec. 11.3, Program Function Descriptions.

<phase function> =>

Rate Data Functions

When a Phase's function is set to a "Rate Data Function", use the 'RAT', 'VOL', and 'DIR' commands to setup the pumping parameters.

RAT	Pumping rate. 'RATE'
INC	Increment rate. 'INCR'
DEC	Decrement rate. 'DECR'

Non-Rate Data Functions

STP	Stop pump. 'STOP'
JMP <phase data>	Jump to Program Phase. 'JP:nn'
LOP <count data>	Loop to previous loop start 'nn' times. 'LP:nn'
PRI	Program Selection Input. 'Pr:In'
PRL <count data>	Program Selection Label definition. 'Pr:nn'
LPS	Loop starting Phase. 'LP:ST'
LPE	Loop end Phase. 'LP:EN'
PAS <number data>	Pauses pumping for 'nn' seconds. 'PS:nn'
PAS <n.n>	Pauses pumping for 'n.n' seconds. 'PS:n.n'
IF <phase data>	If Program input TTL pin low, jump to Phase. 'IF:nn'
EVN <phase data>	Set event trigger trap. 'EV:nn'
EVS <phase data>	Set event square wave trigger trap. 'ES:nn'
EVR	Event trigger reset. 'EV:RS'
BEP	Sound short beep. 'BEEP'
OUT <TTL level>	Set programmable output pin. 'OUT.n'

PUMPING RATE

RAT [<float> [<rate units>]]

Set/query pumping rate.

<rate units> =>	OM	= Oz/min
	MM	= mL/min

OS = Oz/sec
MS = mL/sec

Applicable only with “Rate Data Functions”.

When setting the pumping rate, if the current Phase’s function is not ‘RATE’, then <rate units> is not applicable.

While pumping, the pumping rate can only be set if the current Phase function is ‘RATE’ and the next Program Phase’s function to be executed is not ‘INCR’ or ‘DECR’. Also, while pumping, <rate units> cannot be set.

The new pumping rate will only be stored in non-volatile memory if the Pumping Program is not operating.

When the pumping rate is queried while pumping, the response will be the current pumping rate and units. Otherwise, the response will be the rate setting and units, if applicable. With the ‘INCR’ and ‘DECR’ functions, these two responses are not the same.

If a pumping dispense time is set, the query response will be the dispense time in [minutes : seconds].

PUMPING DISPENSE TIME

TIM [<nn> : <nn>]

Set pumping dispense time and rate units to [minutes : seconds].

Query will return the current time setting, or the pumping rate if dispense time not set.

VOLUME TO BE DISPENSED AND SET VOLUME UNITS

VOL [<float> | <volume units>]

Set/query volume to be dispensed: <float>

Applicable only with “Rate Data Functions”. Can only be set when the Pumping Program is not operating. The volume units are set according to the current diameter setting. Do not send the volume units when setting the volume.

Example: VOL 12.45 Sets the current phase “Volume to be Dispensed” to 12.45.

Set volume units: <volume units>

Overrides the default volume units set when the diameter is set.

Example: VOL OZ Sets all volume units to Oz.

Query response:

<float> <volume units>

PUMPING DIRECTION

DIR [INF | WDR | REV]

Set/query pumping direction

INF = Dispense

WDR = Withdraw

REV = Reverse pumping direction

Applicable with all Program Phase functions. Cannot be set when the Pumping Program is operating and the “Volume to be Dispensed” is non-zero.

The pumping direction cannot be changed if an alarm condition exists.

Query response: { INF | WDR }

12.4.2 Pump Operational Commands

START PUMPING PROGRAM

RUN [<phase data>]

[E [<phase data>]]

Starts the Pumping Program operation.

If the Pumping Program was paused, then the Pumping Program resumes at the point where it was stopped. Otherwise, the Pumping Program starts from Phase 1.

If a Phase number is specified (<phase data>), then the Pumping Program will start at the specified Phase number.

The pump cannot be started if an alarm condition exists.

E [<phase data>]

Trigger a Pumping Program Event.

Triggers a pre-defined event defined with the Pumping Program's Event function, causing an immediate jump to the Pumping Program Phase defined by the event function.

If <phase data> is specified, the program will immediately jump to the Pumping Program Phase specified by <phase data>, and cancel any other event set by the Pumping Program.

STOP PUMPING PROGRAM

STP

If the Pumping Program is operating, the pump will be stopped and the Pumping Program will be paused.

If the Pumping Program is paused, the stop command will cancel the pause and reset the Pumping Program to Phase 1.

VOLUME DISPENSED

DIS

Queries volume dispense only. Set not applicable.

Response:

I <float> W <float> <volume units>

Where: "I <float>" refers to the volume dispensed, and "W <float>" refers to the volume withdrawn.

CLEAR VOLUME DISPENSED

CLD { INF | WDR }

Sets the Dispensed or withdrawn volume dispensed to 0. Command is only valid while the Pumping Program is not operating. Query is not applicable.

INF = Dispense volume

WDR = Withdrawn volume

Query is not applicable.

12.4.3 Configuration and Setup Commands

New settings for any of the following commands will be stored in the non-volatile memory.

DISPENSE PAUSE MODE

PSM [nn | n.n]

Set/query "Dispense, Pause Dispense" mode, where 'nn' is the pause time in seconds. If set to 0, Dispense Pause Mode is disabled

SLOW DOWN MODE

SLO [<on-off>]

Set/query dispense slow down mode. Set enables or disables slow down mode.

ANTI-DRIP MODE

DRP [<on-off>]

Set/query dispense anti-drip mode. Set enables or disables anti-drip mode.

ALARM SETUP

AL [<on-off>]

Set/query alarm setup mode. Set alarm enables or disables alarm buzzer mode.

POWER FAIL SETUP

PF [<on-off>]

Set/query Power Failure mode. Set Power Failure enables or disables Power Failure mode.

TTL I/O OPERATIONAL TRIGGER SETUP

TRG [<trigger setup>]

Set/Query TTL I/O Operational Trigger input configuration.

TTL I/O Operational Trigger is set to <trigger setup>.

<trigger setup> =>	FT	= Foot switch trigger (falling edge start/stop)
	FH	= Foot switch hold (falling edge start, rising edge start)
	F2	= Foot switch reverse (rising edge start/stop)
	LE	= Level trigger (rising edge start, falling edge stop)
	ST	= Start only trigger (falling edge start)
	T2	= Start only trigger reversed (rising edge start)
	SP	= Stop only trigger (falling edge stop)
	P2	= Stop only trigger reversed (rising edge stop)

TTL I/O DIRECTIONAL CONTROL INPUT SETUP

DIN [0 | 1]

Set/query directional control input setup

Settings => 0 = Falling edge: Dispense, Rising edge Withdraw

Same as "dr:rE" setting from the keypad.

Use this setting with the CBL-TTL-1, reciprocating pump cable, to create a 2 pump continuous dispense system

1 = Falling edge: Withdraw, Rising edge Dispense

Same as "dr:dU" setting from the keypad.

Use this setting with the CBL-TTL-1, reciprocating pump cable, to create a 2 pump dual pumping system

PUMP MOTOR OPERATING TTL OUTPUT CONFIGURATION

ROM [<on-off>]

Set/query Pump Motor Operating TTL output configuration (TTL pin 7)

Settings => 0 = Output is logic high only when the pump motor is operating (pumping).

1 = Output is logic high when the pump motor is operating (pumping) or when the Pumping Program is executing a pause timer.

SET KEYPAD LOCKOUT

LOC [P | D] [<on-off>]

Set/query keypad lockout mode. Set keypad lockout disables changing any settings from the keypad unless the "Lockout Disable Key" is inserted.

P [<on-off>]

Set/Query Program Entry Mode Lockout. Set Program Entry Mode Lockout prevents inexperienced users from entering "Program Entry Mode" from the keypad. When enabled, only the Phase 1 'Rate', 'Volume' and Pumping Direction can be changed. Cannot be enabled when the Pumping Program is currently programmed with a multiple Phase Program.

D [<on-off>]

Set/Query Dispense Mode. Set Dispense Mode allows quick setup and selection of dispenses. Turn off to enter a Pumping Program.

SET KEY BEEP

BP [<on-off>]

Set/query key beep mode. Set key beep enables or disables key beep mode.

12.4.4 General Control and Status Commands

TTL I/O OUTPUT SETTING

OUT <n> <TTL level>

Sets TTL level on user definable output pin on the 'TTL I/O' connector.

<n> Indicates pin number on 'TTL I/O' connector

Valid value: 5 (Program Output pin)

Query is not applicable.

TTL INPUT QUERY

IN <n>

Queries TTL level of pin on 'TTL I/O' connector. Set is not applicable.

<n> Indicates pin number on 'TTL I/O' connector

Valid values: 2, 3, 4, and 6.

Query response: <TTL level>

BUZZER

BUZ [0 | { 1 [<n>] }]

Sets / queries buzzer

Set: 0 = Turn buzzer off;

1 = Turn buzzer on

if <n> specified

If <n> = 0, buzzer beeps continuously,
otherwise buzzer beeps <n> times

if <n> not specified, buzzer sounds continuously

Query response: { 0 | 1 }

0 = Buzzer off

1 = Buzzer is on continuously or beeping.

12.4.5 System Commands

SET PUMP NETWORK ADDRESS AND BAUD RATE

* ADR [<address> [B { 19200 | 9600 | 2400 | 1200 | 300 }]]
[DUAL | RECP]

Set/query pump network address

<address> => <n> [<n>]

<address> Valid range: 0 to 99

B { 19200 | 9600 | 2400 | 1200 | 300 } will change the baud rate as indicated. NOTE: The command response and all further communications will be at the specified baud rate.

DUAL Sets the pump to Dual Pumping mode with a secondary pump.

RECP Sets the pump to Reciprocating Pumping mode with a secondary pump.

With both Dual and Reciprocating modes, the baud rate defaults to 19,200.

This is a special system command that will be accepted by the pump regardless of its current address. Once set, the pump will only respond to commands with the set address and at the specified baud rate.

Note: Once DUAL or RECP is set, the pump will only respond to commands that are preceded by the '*' character. To exit DUAL or RECP mode, reset the address: * ADR 0

Example: *ADR	Query current address setting
*ADR 3	Set pump network address to 3. The pump will now only respond to commands with address 3
*ADR 5 B 1200	Set the pump network address to 5 and the baud rate to 1200. The command response will be at 1200 baud

ENABLE SAFE COMMUNICATIONS MODE

SAF [<time out>]

Set/query Safe communications mode setting.

<time out> => <n> [<n> [<n>]]

<time out> Valid range: 0 to 255.

If <time out> = 0 then Basic communication mode is set, disabling Safe mode,

If <time out> > 0 then Safe communications mode is enabled. After the reception of this command, valid communications must be received every <time out> seconds.

FIRMWARE VERSION QUERY

VER

Response: NE<model>V <n> . <nn>

where '<n>.<nn>' is the current firmware version number.

Set is not applicable.

MASTER PROGRAM RESET

* RESET

Clears program memory and resets communication parameters to Basic mode and address 0.

This is a special system command that will be accepted by the pump regardless of its current address.

12.5 Getting Started With RS-232

Before beginning to develop pump control software for a computer, first setup and experiment with the pump's communication. After attaching the pump to the computer, run a terminal emulation Program on the computer. A generic terminal emulator, supplied as standard software with many computers, can be used to communicate with the pump in the Basic communications mode.

A terminal emulator is available at, (www.syringepump.com/accessories.htm#software) for demonstration purposes only, which allows more complex control of the pump. Also, this terminal emulator contains a “Pump Programming Language” (PPL™), which allows Pumping Programs to be developed using symbolic text, modified, and stored in computer files, then downloaded to the pump.

With a generic terminal emulator, setup the terminal emulator with the same baud rate as the pump and with an 8 bit data, no parity, and 1 stop bit (8N1) data frame. Set the communications port to the port that is attached to the pump. Also enable local echo (half-duplex) and turn flow control off.

From the terminal emulator, you can interactively control the pump by typing in commands on your computer and seeing the pump’s responses on your screen. This will give you a feel for how the commands work in addition to allowing you to quickly develop the control sequence that will eventually be coded into the software being developed.

The final benefit of using a terminal emulator is the elimination of several variables if the control software does not work properly. If the pump works correctly with the terminal emulator, then this verifies that the hardware is working properly and will work with any software. Any communications problems can then be narrowed down to the control software.

SyringePumpPro software provides licensed Windows GUI based control program for this pump.

Note on USB: If an RS-232 port is not available on your PC, the pump may be operated through a USB to RS-232 cable (available as an accessory). The PC will create a virtual RS-232 communications port that communicates through the USB to RS-232 cable. The terminal emulator can communicate through this virtual port.

13. Logic Interface: TTL Input and Output

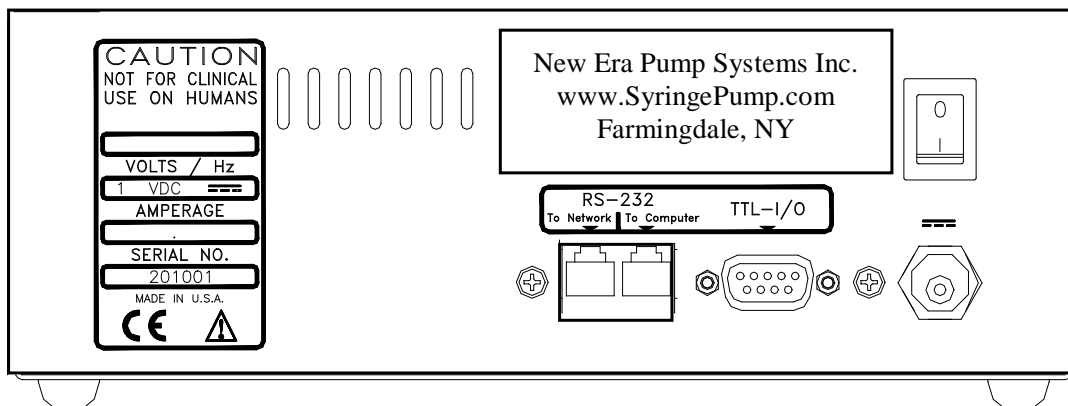

Figure 2: Rear of Pump

On the rear of the pump is a DB-9 connector, below the ‘TTL-I/O’ label, which is used for TTL I/O. The logic signals on this connector permit bi-directional control with external equipment.

Control input TTL logic levels must be held steady for a minimum of 100 ms to be recognized. To minimize the possibility of false signals caused by glitches and ringing, which could be caused by the closure of mechanical switches, TTL control inputs are software filtered. With a sampling period of 50 ms, glitches of less than 100 ms are filtered out.

Edge detection requires the detection of a change in TTL levels. With a minimum of 100 ms to detect a level, an edge requires a minimum of 200 ms to be detected. Since the next level change can be detected in 100 ms, creating another edge, the maximum edge to edge frequency is 10 Hz.

Edge changes to the ‘Pumping Direction’ and ‘Operational Trigger’ inputs must occur at least 50 ms apart.

Falling edge refers to a logic high to logic low transition. Rising edge refers to a logic low to a logic high transition. To guarantee recognition of logic levels, voltages on the input lines must be within the following ranges:

TTL logic low (0):	0 to 1.5 V
TTL logic high (1):	3.5 to 5.25 V

The Vcc and Ground pins, pins 1 and 9, are for logic reference only. To assure proper voltage levels, the Ground pin should always be connected to the signal ground of a sensing or controlling device that is attached to any other pin on the TTL I/O connector. The Vcc pin should not be used to source current. The TTL I/O pins are defined as follows:

Pin #	Definition	Type	Function
1	Vcc (5V)	Reference	Logic high reference. Power on indicator.
2	Operational Trigger	Input	Configurable start/stop operational trigger input. [Ft] Foot Switch Falling edge: Start or stop trigger [FH] Foot Switch Hold Falling edge: Start trigger Rising edge: Stop trigger [F2] Foot Switch Reverse Rising edge: Start or stop trigger [LE] Level Falling edge: Stop trigger Rising edge: Start trigger [St] Start only Falling edge: Start trigger [t2] Start only Reverse Rising edge: Start trigger [SP] Stop only Falling edge: Stop trigger [P2] Stop only Reverse Rising edge: Stop trigger
3	Pumping Direction	Input	Changes pumping direction according to setup [dr:rE] [dr:dU] Falling edge: Dispense Withdraw Rising edge: Withdraw Dispense
4	Event Trigger	Input	Event input or user definable input
5	Program Output	Output	Program controlled output or user definable output
6	Program Input	Input	Program conditional input read by the “IF” program function. Also user definable input. Also used by the keypad lockout function.
7	Pump Motor Operating	Output	[RUN.0] High: Pumping; Low: Not pumping [RUN.1] High: Pumping or Pause timer Low: Pumping Programmed stopped or paused
8	Pumping Direction	Output	High: Dispense; Low: Withdraw
9	Ground (0V)	Reference	Logic low reference

13.1 TTL I/O Operational Controls

While the user is changing settings or configuration from the keypad, external control by the ‘Pumping Direction’ and ‘Operational Trigger’ inputs will be ignored. These controls will also be ignored if an alarm condition exists.

Operational Trigger (Pin 2): The input signal on this pin controls the operation of the Pumping Program. Its functionality is user configurable. Use the ‘TR:nn’ Setup Configuration to configure this input pin (See Section 10.7, TTL I/O Operational Trigger Configuration).

Each option defines when the Operational Trigger input is activated. When activated, the trigger emulates the ‘Start/Stop’ key:

Foot Switch: Operates like the 'Start/Stop' key, whereby each **falling** edge (contact to ground) either starts or stops/pauses the Pumping Program.

Foot Switch Hold: **Falling** edge starts the Pumping Program and the **rising** edge stops the Pumping Program. With a foot switch, the Pumping Program will run while the foot switch was held down.

Foot Switch Reversed: Operates like the 'Start/Stop' key, whereby each **rising** edge either starts or stops/pauses the Pumping Program.

Level Control: **Falling** edge stops/pauses the Pumping Program, **Rising** edge starts the Pumping Program. This configuration can be used with a contact closure timer or in an automation setup, allowing logic level control over the operation of the pump.

Start Only: **Falling** edge starts the Pumping Program. This configuration only allows the starting of the Pumping Program. This would be useful, for example, with a laboratory animal trained to press a lever. The animal can start the Pumping Program, but repeated presses would have no effect until the Pumping Program permits it.

Start Only Reversed: Same as 'Start Only', but operates on the **Rising** edge to start the Pumping Program.

Stop Only: **Falling** edge Stops the Pumping Program. This configuration only allows the stopping/pausing of the Pumping Program. This would be useful, for example, with an end of travel limit switch. Also, this switch can be used as a power on homing switch.

Stop Only Reversed: Same as 'Stop Only', but operates on the **Rising** edge to stop the Pumping Program.

Pump Motor Operating (Pin 7): This output provides an external signal indicating when the pump

motor is operating. This pin is configured with the  setup command, or the "ROM" remote command. When set to 0, the output is only at logic high when the motor is operating (pumping). When set to 1, the output is logic high when the motor is operating or when the Pumping program is executing a pause timer. Otherwise, the output is a logic low.

Pumping Direction Controls (Input: Pin 3; Output: Pin 8): Allows bi-directional control of the pumping direction. The input pin, when activated, emulates the pumping direction key, changing the pumping direction. This function, therefore, is only applicable where the pumping direction key would be

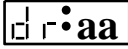
applicable. The function of the input pin is configured with the  setup command, or the "DIN" remote command.

When the mode is set to reciprocating pumps ("RE" setup command or "0" remote), then if the current pumping direction is withdraw, a falling edge sets the direction to dispense. If the current pumping direction is dispense, a rising edge sets the direction to withdraw. Otherwise, this input pin has no effect.

When the mode is set to dual pumps ("dU" setup command or "1" remote), then if the current pumping direction is withdraw, a rising edge sets the direction to dispense. If the current pumping direction is dispense, a falling edge sets the direction to withdraw. Otherwise, this input pin has no effect.

Dual and reciprocating pumping systems are created using 2 pumps attached with the accessory cable CBL-TTL-1.

The output pin provides an output signal to external devices indicating the direction of pumping. A logic low indicates withdraw, and a logic high indicates dispense. For example, this pin can be used to control an external valve.

13.2 TTL I/O Control from the Pumping Program

Various Pumping Program functions can define how the pump reacts to levels on the TTL I/O connector or set output levels. These are summarized in the following table:

Pumping Program Function	TTL I/O Control Pin	Pin #	Action
OUT.n	Program Output	5	Set logic level output to 'n'
EV:nn	Event Trigger	4	Falling edge triggers a jump to Phase 'nn'
ES:nn	Event Square wave Trigger	4	Rising or falling edge triggers a jump to Phase 'nn'
IF:nn	Program Input	6	Low level causes a jump to Phase 'nn'
PS:00	Operational Trigger	2	Trigger activation resumes Program operation

13.3 TTL I/O Control from RS-232

The logic levels of pins 2, 3, 4, and 6 can be queried from an attached computer using the RS-232 'IN' command.

The output logic level of pin 5 can be set with the RS-232 'OUT' command.

14. Appendix

14.1 RS-232 Command Summary

<command> =>

DIA [<nn> / <nn>]	Tube inside diameter
CAL <float>	Tubing calibrated volume
PHN [< phase data >]	Program Phase number
FUN [< phase function >]	Program Phase function
< phase function > =>	
RAT	Pumping rate. 'RATE'
INC	Increment rate. 'INCR'
DEC	Decrement rate. 'DECR'
STP	Stop pump. 'STOP'
JMP <phase data>	Jump to Program Phase. 'JP:nn'
PRI	Program Selection Input. 'Pr:In'
PRL <phase data>	Program Selection Label definition. 'Pr:nn'
LOP <count data>	Loop to previous loop start 'nn' times. 'LP:nn'
LPS	Loop starting Phase. 'LP:ST'
LPE	Loop end Phase. 'LP:EN'
PAS [nn n.n]	Pauses pumping for 'n.n' seconds. 'PS:n.n'
IF <phase data>	If Program input low, jump to Program Phase. 'IF:nn'
EVN <phase data>	Set event trigger. 'Et:nn'
EVS <phase data>	Set event square wave trigger. 'ES:nn'
EVR	Event trigger reset. 'Et:RS'
BEP	Sound short beep. 'BEEP'
OUT { 0 1 }	Set programmable output pin. 'OUT.n'
RAT [<float> [MS OS MM OM]]	Pumping rate
VOL [<float> <volume units>]	Volume to be Dispensed
TIM [<nn> : <nn>]	Volume / Time units and time setting
DIR [INF WDR REV]	Pumping direction
RUN [<phase data>]	Starts the Pumping Program
[E [<phase data>]]	Pumping Program event trigger
STP	Stop/pauses the Pumping Program
DIS	Query volume dispensed
CLD { INF WDR }	Clear volume dispensed
PSM [nn n.n]	Dispense pause mode
SLO [0 1]	Slow down mode
DRP [0 1]	Anti-drip mode
AL [0 1]	Alarm mode
PF [0 1]	Power failure mode

TRG [FT FH F2 LE ST T2 SP P2]	Operational trigger mode
DIN [0 1]	Directional input control mode
ROM [0 1]	Pump Motor Operating TTL output mode
OUT 5 { 0 1 }	Set TTL output level
IN { 2 3 4 6 }	Query TTL input level
BUZ [0 { 1 [<n>] }]	Buzzer control
BP [<on-off>]	Key beep mode
LOC [P D] [0 1]	Keypad lockout mode or Program Entry Mode lockout
VER	Query firmware version
SAF [<n> [<n> [<n>]]]	Safe communications mode
*ADR [<n> [<n>] [B <baud-rate>]]	Network address and baud rate (system command, valid regardless of current address)
*ADR [DUAL RECP]	Set Reciprocating or Dual pumping mode
*RESET	Clears program memory and resets communication parameters (system command, valid regardless of current address)

Network Command Burst => <n> <command> * [Network Command Burst]
Communicate with multiple pumps on a pump network simultaneously

Refer to section [10.2.1 RS-232 General Syntax Legend](#) for symbol's description.

14.2 RS-232 Pump Network Connector Wiring

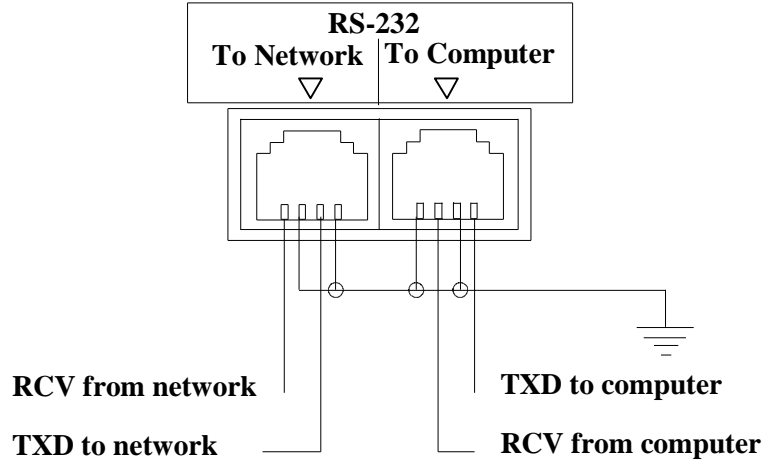

PC Com Port Connectors

25 Pin

3 - Receive
2 - Transmit
9 - Ground

9 Pin

2 - Receive
3 - Transmit
5 - Ground

Connect to pump TXD
Connect to pump RCV
Connect to pump GND

14.3 Accessories

14.3.1 ANA-BOX

Part #: ADPT-ANABOX, Analog sensor interface.

Allows the NE-9000 to be controlled by an external sensor, such as a pressure sensor, or other variable voltage source. Start or stop the pump at a specific voltage level. Set the pumping rate to be proportional to the voltage input. Creates a closed loop system.

14.3.2 RS-232 Network Cables

RS-232 Network Primary Cable

7 foot cable, part #: CBL-PC-PUMP-7
25 foot cable, part #: CBL-PC-PUMP-25

Cable to connect a pump, or the first pump in a pump network, to a standard personal computer's serial port with a DB-9 or DB-25 connector. Included with this cable is a 9 pin to 25 pin converter.

RS-232 Network Secondary Cable

7 foot cable, part #: CBL-NET-7
25 foot cable, part #: CBL-NET-25

Cable to connect additional pumps, after the first pump, to the pump network.

USB to RS-232 converter cable

USB to RS-232 cable, software drivers on CD, part#: CBL-USB232
Attached to the RS-232 Network Primary Cable, allows communication through a PC's USB port.

14.3.3 Automation Cable: Dual Pumps Control Cable

Part #: CBL-DUAL

Using two NE-9000 peristaltic pumps, this cable creates a dual pumping system, with both pumps operating in the same direction.

This cable is attached to two NE-9000 peristaltic pumps via their RS-232 connectors. In this setup, with the pumps configured for this operation, one pump acts as the Master controller. The pumps can be set to Dual Pump Mode, whereby the second pump will always follow the program on the first pump, including starting, stopping, direction changes, and rate changes.

When either pump stops, for any reason, the other pump will stop.

14.3.4 Valve Controller

Part# ADPT-VALVE-INTERFACE-1 (For one pump)

Part# ADPT-VALVE-INTERFACE-2 (For two pumps, includes CBL-TTL-1)

Provides a control interface for your electronic valves. Attach your electronic valves, and the interface will control the activation of the valves. The 2 pump interface is used to create a continuous dispense/refill system.

14.3.5 Foot Switch

Part #: ADPT-2

Allows the pump to be operated from a foot switch. Attaches to the TTL I/O connector.

14.3.6 Lockout Disable Key

Part#: ADPT-LOCKOUT-KEY

Enables setting Keypad Lockout mode and allows changing of settings while Keypad Lockout is set.

14.3.7 Firmware Upgrade

Part#: CPU-NE9000, Upgraded firmware.

Contact your dealer for this upgrade and to determine the current available version of the pumps internal firmware.

14.4 Troubleshooting and Maintenance

Maintenance: Periodically, a new tube should be used or a new section of peristaltic tubing should be used. Add grease to the Cassette shaft and the surface of new tubing.

Pump head may need to be replaced once a year depending on usage.

The mechanism should be kept clean to prevent wear and tear.

RS-232 Communications: If no RS-232 communications is possible or garbled responses are received from the pump, check the following:

If the triangle appears in the upper left of the LCD display, then the pump is receiving valid communications. The communications problem is probably with the receiving communication application or with the receive line on the cable.

If the Basic communications mode is used, check if the pump is in Safe communications mode. See section 12.2, RS-232 Protocol:, for instructions on how to change the communications mode.

Verify the pump's baud rate and network address. To set the RS-232 communications parameters, see section 6.13, 'Setup' .

Using a lower baud rate may also improve the reliability of the RS-232 communications.

Pump stalls and is unable to turn: This may be because the pumping rate is set too high. Reduce rate. Peristaltic tubing being used may be too rigid for this pump. Replace tubing. Liquid may be too viscous or there may be too much pressure on the system.

There may be too much tubing in the pump head, reduce distance between tie-raps and recalibrate pump, refer to section 4.2.1.

Pump doesn't stop after dispensing a set volume: The pump was previously setup with a multiple Phase Pumping Program. To simply dispense a fixed volume at a fixed pumping rate, the second Program Phase must be the 'Stop' function. See section 11.1, How to Enter Pumping Programs, for instructions on changing the Pumping Program.

Pump stops pumping after a period of time: A dispense volume has been set. Verify that the dispense volume is set to 0.

14.5 Specifications

14.5.1 Mechanical & Electrical

Number of pumps:	1
Motor type:	Step motor
Motor steps per revolution:	200
Microstepping:	1/8 to 1/1 depending on motor speed
Power connector:	2.1mm, center positive
Voltage at power connector:	24V DC
Amperage:	900mA at full load
Power supply type:	Unregulated linear external wall adapter, country and power source specific
Power supply output rating:	24V DC @ 1A
Dimensions:	7 3/4" x 5 1/4" x 5 3/4" High (19.685 cm x 13.335 cm x 14.605 cm)
Weight:	4.51 lbs. (2.05 kg)

14.5.2 Operational

Maximum speed:	372 rpm
Minimum speed:	0.0168 rpm
Maximum pumping rate:	775.2 mL/min with 3/16 ID tubing
Minimum pumping rate:	0.035 mL/min with 3/16 ID tubing
Number of Program Phases:	40
RS-232 pump network:	100 pumps maximum
RS-232 selectable baud rates:	300, 1200, 2400, 9600, 19200
Tubing inside diameter range:	Below 1" diameter

14.6 Custom Applications

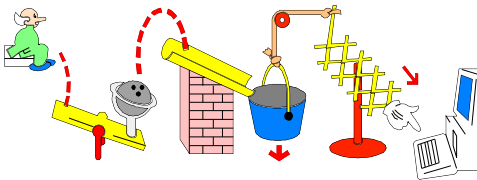

For specialized and OEM applications, contact your dealer or NEW ERA PUMP SYSTEMS INC.. Custom modifications can be made to the mechanics or the firmware.

14.7 Flow Rate Limits

Note: The following flow rates and volumes are adjusted accordingly when the pump is calibrated.

Tube Size ID X OD [in]	Approximate Volume Dispensed Per 1 revolution	Head [in]	Flow Rate (mL/min)	
			Maximum	Minimum
1/4 x 3/8	2.790 mL (0.0944 US fl.oz)	1/4 (clear)	1038	0.047
3/16 x 5/16	2.084 mL (0.0704 US fl.oz)	3/16 (blue)	775.2	0.035
1/8 x 1/4	0.926 mL (0.0313 US fl.oz)	3/16 (blue)	344.5	0.016
3/32 x 7/32	0.455 mL (0.0154 US fl.oz)	1/16 (green)	169.1	0.008
1/16 x 3/16	0.202 mL (0.0068 US fl.oz)	1/16 (green)	75.19	0.004

14.8 Tube Chemical Characteristics

⚠ Tubing Chemical compatibility list mentioned is only a guide. The user is responsible to determine the tubing compatibility to the chemical being used.

This Peristaltic pump will only work with tubing with 1/16 [1.6mm] wall, peristaltic tubing that is relatively flexible, and that can be easily compressed.

Thus we have a couple of recommendations:

	Sterilization						
	Auto-clavable(2)	Gas(3)	Radiation(4)	Color	Odor	Taste	Toxicity
Tygon® LFL	Yes	Yes	No	Clear	Slight	None	Non-toxic
Tygon® R-3603	Yes	N/A ⁽⁶⁾	No	Clear	Slight	None	Non-toxic
Tygon® R-1000	No	N/A ⁽⁶⁾	No	Clear	Slight	-1	-1
Tygon® 2001	Yes	N/A ⁽⁶⁾	N/A ⁽⁶⁾	Clear	None	None	Non-toxic
Tygoprene™ XL-60	Yes	N/A ⁽⁶⁾	N/A ⁽⁶⁾	Translucent	Slight	Slight	Non-toxic
Fluran® F-5500-A	N/A ⁽⁵⁾⁽⁷⁾	No	No	Black	Slight	-1	-1
Norprene® A-60-G	N/A ⁽⁵⁾	N/A ⁽⁵⁾	N/A ⁽⁵⁾	Black	Slight	-1	-1
Norprene® A-60-F	Yes	N/A ⁽⁶⁾	N/A ⁽⁶⁾	Beige	Slight	Slight	Non-toxic
PharMed® BPT	Yes	Yes	Yes	Tan	Slight	Slight	Non-toxic

⁽¹⁾Not to be used in contact with food, beverages, drugs

⁽²⁾Steam 30 minutes at 15 psi (250).

⁽³⁾Ethylene Oxide.

⁽⁴⁾Radiation up to 2.5 MRad.

⁽⁵⁾Restricted to chemical/industrial use only.

⁽⁶⁾Not a medical formulation.

⁽⁷⁾Food grade is available upon request.

Visit <http://www.tygon.com> for more details

Tygon® is a registered trademark of Saint-Gobain Performance Plastics Corporation.

All sponsored products, company names, brand names, trademarks and logos are the property of their respective owners.